

E-Mail

**PRASAR BHARTI**  
**(India's Public Service Broadcaster)**  
**Directorate general of Doordarshan**  
**Doordarshan Bhawan, Copernicus Marg**  
**New Delhi -110001.**

**File No.** 19(2)2023-24EI(P)TVDraftspecifications Dated : 19/02/2024

**Subject:** Technical Specification along with Suggestive Block Diagram and Suggestive Bill of Material (BOM) for **SITC of additional two streams with RF Systems at earth station Todapur Delhi.**

The Technical specification of the upcoming tender is enclosed herewith to offer comments, if any by prospective bidders/Firms. Please also submit budgetary quote **of proposed solution / equipment covered under "Make in India" policy in percentage of the total cost as per BOM** on or before due date at e-mail [ddpurchase401@yahoo.co.in](mailto:ddpurchase401@yahoo.co.in) or on following Address:

Assistant Engineer  
Room No. 403,  
Directorate General: Doordarshan,  
Doordarshan Bhawan, Copernicus Marg,  
New Delhi -110001 (India)  
Telephone: 011- **2311 4401**

**Specification For:** SITC of additional two streams with RF Systems at earth station Todapur Delhi.

**Specification no:** SATD/DD FreeDish Expension\_Additional Two Stream/Feb 2024 Dated 12/02/2024

**Due Date to offer Comments:** 04.03.2024 at 17.00 hrs.

Encl.: As above (137 Pages)

Signed by Narendra Kumar  
Choursiya  
Date: 20-02-2024 10:31:52  
Reason: Approved  
Assistant Engineer  
For DG:DD

Appendix D

**Prasar Bharati**  
**(India's Public Service Broadcaster)**  
**DIRECTORATE GENERAL; DOORDARSHAN**

**TECHNICAL SPECIFICATIONS**  
**FOR**  
**EXPANSION OF DD FREEDISH PLATFORM BY**  
**SITC OF ADDITIONAL TWO STREAMS WITH RF SYSTEMS**  
**AT**  
**EARTH STATION TODAPUR**  
**DELHI**

Specification No.: SATD/DD FreeDish Expansion\_Additional Two Streams /Feb.2024

Dated: 12/02/2024

*Handwritten signature/initials*

*Handwritten signature/initials*

*Handwritten signature: Himanshu G*

**TECHNICAL SPECIFICATIONS FOR EXPANSION OF DD FREEDISH  
PLATFORM BY SITC OF ADDITIONAL TWO STREAMS WITH RF SYSTEMS AT  
EARTH STATION TODAPUR DELHI**

**INDEX**

Sl. No.	Item	Page No.
1	Introduction	3
2	Scope of Work	4
3	Work Experience for Vendor and OEM	10
4	Turnkey Implementation and Commissioning	13
5	Technical Specification of Major Equipment	21
5.1	Input and Base Band System	21
5.2	Digital Compression System	31
5.3	Satellite Modulator System	57
5.4	RF System	61
5.5	Monitoring System	68
5.6	Measuring System	82
5.7	Power Supply System	94
6	Complement of Equipment for the DTH system	95
7	Physical, Environmental & Mech. Specs	96
8	General	96
9	Annexure-II of Appendix-D	103
10	Annexure-III of Appendix-D	104
11	Annexure-IV of Appendix-D	105
12	Annexure-V of Appendix-D	106
13	Annexure-VI of Appendix-D	108
13	Suggestive Block Schematics - Annexure-VII of Appendix-D	109-123
14	Suggestive Bill of Material -Annexure-I of Appendix-D	124-137

amh

Lok

12/22

Shimanshu

## SATD/DD FreeDish Expansion\_ Additional Two Streams /Feb 2024

## 1. Introduction

This project envisages expansion of Doordarshan's present DD FreeDish platform. Presently, DD FreeDish Platform is up-linking 94 TV channels & 40 Radio channels in MPEG-2, DVB-S standard in free to air mode by using 5 transponders and 22 TV channels(20 SD + 2 HD) & 8 Radio channels in MPEG-4, DVB-S2 standard with DVB-CAS compliant headend in one transponder.

DD FreeDish platform is proposed to be expanded by providing additional two streams with RF Systems in addition to existing six streams. It has provision for uplinking of HDTV and SDTV channels. Inclusion of each HDTV channel in H.265/HEVC will result in a loss of few SDTV channels.

### 1.1 Proposed Expansion

#### 1.1.1. Compression Configuration (Encoders, IP Encapsulator / Mux and NMS)

Stream Name	Proposed System				
	Configuration of TV & Radio Encoder Chassis		DVB-CAS	Compression Standard	Uplink Standard
7	(X+2) SDTV & HDTV	8 Radio Channel	Yes	i) SD-MPEG-2 & MPEG-4 ii) HD-MPEG-4 & HEVC	DVB-S & DVB-S2
8	(X+2) SDTV & HDTV	8 Radio Channel	Yes	i) SD-MPEG-2 & MPEG-4 ii) HD-MPEG-4 & HEVC	DVB-S & DVB-S2

Note: X: No. of Encoder chassis required as per technical specification of Compression system for SDTV & HDTV channels and Radio Channel.

All the offered equipment shall be Conditional Access System (CAS-Generic) compliant for encryption & decryption of all services. Services like DVB-CSA (V-1 & V-2) supported DVB-CAS with simulcrypt encryption, Subtitling, Audio descriptor, EPG, closed captioning etc will be carried by the DD FreeDish platform and the equipment offered by the bidder shall be capable of carrying these services without any limitation or requiring upgradation by way of hardware and software. The offered Compression System shall also be Video on Demand (VoD) & NVoD with .TS format compliant, however Storage server, Play out system, GSM or IP based network for return path are not in the scope of this tender.

## 1.1.2. IF and RF System: (Modulator, Upconverter, HPA, RF System)

Transponder No.	Proposed System				Remarks
	Configuration of Satellite Modulator and Ku band upconverter		Configuration of HPA	Uplink Antenna System	
K-15	(1+1) DVB-S & S-2 compliant Satellite Modulator	(1+1) IF to Ku band Converter	(1+1) RF Amplifier	Existing 9.0 mtr. RF Uplink Parabolic Dish Antenna System No. 2 and 3 (at a time any one)	RF output of 1+1 HPA shall be combined with existing 3+1 HPA system and feed to H-Pole of Antenna System No. 2 and 3 (At a time any one)
K-7	(1+1) DVB-S & S-2 compliant Satellite Modulator	(1+1) IF to Ku band Converter	(1+1) RF Amplifier	Existing 9.0 mtr. RF Uplink Parabolic Dish Antenna System No. 1 and 3 (at a time any one)	RF output of 1+1 HPA shall be feed to V-Pole of Antenna System No. 1 and 3 (At a time any one)

## 2. Scope of Work

The execution of SITC (Supply, Installation, Testing and Commissioning) is required as stated in "Invitation for Bid" and on the terms specified in the description of Technical Specification for "Expansion of DD FreeDish platform by SITC of additional two streams with RF systems; along with "Instruction to Bidder" at Appendix-A, "General Terms and Conditions" at Appendix-B, and Bid evaluation criteria at Appendix-C of the Bid document.

The scope of this project includes Supply, Installation, Testing and Commissioning (SITC) for two additional streams with RF Systems consisting of but not limited to the Input and Base Band System, Compression system, Modulator system, Monitoring System, Measuring System, RF System including two sets of (1+1) KHPA, two sets of (1+1) Up-convertors system, associated waveguides and Power Supply System and associated works etc for Ku-Band DD FreeDish Platform at Todapur, Delhi. The nomenclature of these two SDTV streams shall be 7<sup>th</sup> and 8<sup>th</sup> stream. All equipment of these streams shall also be capable to take HDTV channel without any limitation or requiring any upgradation by way of hardware and software. These equipment will be

*MA*

*LA*

*2*

*Jimanshu*

used as an alternative to upgrade the SDTV channels to HDTV. Broadly the scope of the project consists of:

- 2.1.1. Bidder shall supply, install, test and commission (SITC) 1 set of L band Line amplifier to be installed in Porta cabin; and supplying & laying of 20 Nos L Band Signal cables from Existing 1:2 Splitter installed in Porta cabin to Line amplifier.
- 2.1.2. Bidder shall supply, install, test & commission (SITC) of 64 Ports 1:4 splitter in old compression room..
- 2.1.3. Bidder shall supply, install, test and commission (SITC) 1 set of L Band Router including minimum 64x192 L-Band Input & Output ports, X-Y/Router control panel with cable, dual redundant power supply units and accessories in old compression room.
- 2.1.4. Bidder shall supply & lay L band Cables between L band Line amplifier (to be installed in Porta cabin) to L band splitter (to be installed in old compression room); also supplying & laying of L band Cables between L band splitter and L band Router to be installed in old Compression room.
- 2.1.5. Bidder shall supply, install, test & commission (SITC), 22 Nos L Band Signal cables from Existing 64 X 192 L band Router- 1 (Main) installed in new Compression Room to 64 X 192 L Band Router installed in existing Compression Room and 22 Nos. Standby L band Cables with Connector from Existing 64 X 192 L band Router- 2 (Standby) installed in new Compression Room to L Band Router installed in existing Compression Room.
- 2.1.6. Bidder shall supply, install, test and commission (SITC) 2 lots of IRDs for SDTV and HDTV channel. Each lot of IRDs shall be offered in (Y+4) chassis configuration, if one professional IRD mounted in one Chassis. Whereas, each lot of IRDs shall be offered in (Y+2) chassis configuration, if more than one professional IRDs mounted in one chassis. Here "Y" is No. of Chassis required to mount/accommodate 28 Nos. Professional IRDs. Further, IRD racks shall be wired for 2 additional chassis of professional IRDs in each lot.
- 2.1.7. Bidder shall supply, install, test and commission (SITC) 2 lots of IRDs for Radio channel. Each lot of IRDs shall be offered in (Z+4) chassis configuration, if one professional IRD mounted in one Chassis. Whereas, each lot of IRDs shall be offered in (Z+2) chassis configuration, if more than one professional IRDs mounted in one chassis. Here "Z" is No. of Chassis required to mount/accommodate 8 Nos. Professional IRDs.
- 2.1.8. Bidder shall supply, install, test and commission (SITC) 2 sets of SD/HD-SDI Router which consist of minimum 64x64 HD-SDI Input & Output ports with X-Y remote control panel and single bus remote control panel. All 64x64 HD-SDI Input & Output ports shall also be capable to take SD-SDI signal without any limitation or upgradation/downgrading by way of hardware and software.

*Handwritten signatures and initials:*  
 [Signature] / [Signature] → [Signature]

- 2.1.9.** Bidder shall supply, install, test and commission (SITC) 2 sets of IP data switch (48 Port) in (1+1) configuration for TV channel and 2 sets of IP Data switch (24 Port) in (1+1) configuration for Radio Channel. Each set of IP data switch in (1+1) configuration shall be used for feeding IP input (Audio/Video & Audio content) to the Encoders of one compression system.
- 2.1.10.** Bidder shall supply, install, test and commission (SITC) 2 sets of compression system having H.264/MPEG-4 and H.265/HEVC compliant Encoders in (X+2) chassis configuration where "X" is no. of chassis comprising of atleast 16 HDTV Encoders with SDI input per stream. "X" no. of these encoder chassis shall also be capable to take atleast 40 SDTV signal with SDI input and compress them to MPEG-2 and H.264/MPEG-4 compression format without any limitation or requiring upgradation /downgrading by way of hardware and software.
- Further, all the above encoder chassis of compression system shall also be capable to take MPEG-2 TS over IP input with decoding of MPEG-2, H.264/MPEG-4-AVC and H.265/HEVC Main 10 compressed contents to baseband signal format. Each encoder chassis with MPEG-2 TS over IP input shall be capable to encode minimum 4 HDTV channel in H.264/MPEG-4-AVC & H.265/HEVC Main 10 (at a time anyone standard) and minimum 16 SDTV channel in MPEG-2 & H.264/MPEG-4 (at a time anyone standard) as tabulated in technical specification without any limitation or requiring upgradation/downgrading by way of hardware and software. The encoding combination of SD & HD Channel is tabulated in encoder specification section.
- 2.1.11.** Bidder shall supply, install, test and commission (SITC) 2 sets of IP data switch in (1+1) configuration. Each set of IP data switch in (1+1) configuration shall be used for feeding IP input (Audio/Video Content) to one set of (1+1) IP Encapsulator system.
- 2.1.12.** Bidder shall supply, install, test and commission (SITC) 2 sets of IP Encapsulator in (1+1) configuration. Each set of (1+1) IP Encapsulator shall be used for transmission of one transport stream.
- 2.1.13.** Bidder shall supply, install, test & commission (SITC) 2 sets of 16x16 or better matrix ASI router with dual redundant power supply, X-Y remote panel and single Bus panel.
- 2.1.14.** Bidder shall supply, install, test & commission (SITC) 2 sets of Compression Network Management System (NMS) in (1+1) configuration to control and monitor new streams i.e. 7<sup>th</sup> and 8<sup>th</sup> streams. Each set of (1+1) Compression Network Management System (NMS) shall control and monitor all compression equipment (i.e. IRDs, SDI Router, Encoders, Multiplexers, ASI Router, IP Switch etc) of one transport stream.

- 2.1.15. Bidder shall supply, install, test and commission (SITC) 2 sets of 3G/HD/SD SDI, DVB/ASI Compliant Distribution Amplifier system for receiving MPEG-2 TS DVB/ASI signal of two new Compression chains in old compression room to Digital Satellite Modulators to be installed in Porta Cabin. One set consisting of two Distribution Amplifiers mounted in one chassis with dual redundant power supply, to be installed in porta cabin and used for each compression chain.
- 2.1.16. Bidder shall supply, install, test and commission (SITC) 2 sets of 3G/HD/SD SDI, DVB/ASI Compliant Distribution Amplifier system for receiving MPEG-2 TS DVB/ASI signal of two existing Compression chains in old compression room to Digital Satellite Modulators to be installed in Porta Cabin. One set consisting of two Distribution Amplifiers mounted in one chassis with dual redundant power supply, to be installed in porta cabin and used for each compression chain.
- 2.1.17. Bidder shall supply, install, test and commission (SITC) 8 sets of 3G/HD/SD SDI, DVB/ASI Compliant Distribution Amplifier system for receiving MPEG-2 TS DVB/ASI signal of four existing Compression chains in new compression room to Digital Satellite Modulators to be installed in Porta Cabin. One set consisting of two Distribution Amplifiers mounted in one chassis with dual redundant power supply. For each compression chain, one set is to be installed in old compression room and another set is to be installed in Porta Cabin.
- 2.1.18. Bidder shall supply and laying of HD SDI cables with matching connectors for receiving MPEG-2 TS /DVB ASI of each four Compression chains (two existing and two offered) (i.e. from respective ASI Routers) in old compression room to Distribution Amplifier system of respective Digital Satellite Modulators to be installed in Porta Cabin.
- 2.1.19. Bidder shall supply and laying of HD SDI cables with matching connectors for receiving MPEG-2 TS /DVB ASI of each four existing Compression chains, from respective Distribution Amplifier system (to be installed in old compression room) to Distribution Amplifier system of respective Digital Satellite Modulators to be installed in Porta Cabin.
- 2.1.20. Bidder shall supply, install, test and commission (SITC) 4 sets of Optical Fiber Communication link (OFC) system for receiving MPEG-2 TS over IP of four Compression chains (two existing and two offered) originated from old compression room to Digital Satellite Modulators to be installed in Porta Cabin. One set Optical Fiber Communication link (OFC) system consisting of two Optical Transmitter mounted in one chassis with dual redundant power supply to be installed in old compression room, two Optical Receiver mounted in one chassis with dual redundant power supply to be installed in porta cabin, required SFP optical device cartridges and standard accessories.

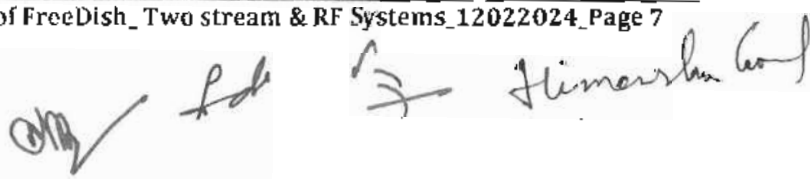
 The bottom of the page contains several handwritten signatures and initials in black ink. From left to right, there is a signature that appears to be 'Om', followed by 'Lok', a stylized signature, and 'Himanshu Goyal'.



- 2.1.21. Bidder shall supply, install, test and commission (SITC) 4 sets of Optical Fiber Communication link (OFC) system for receiving MPEG-2 TS over IP of four Compression chains originated from new compression room to Digital Satellite Modulators to be installed in Porta Cabin. One set Optical Fiber Communication link (OFC) system consisting of two Optical Transmitter mounted in one chassis with dual redundant power supply to be installed in old compression room, two Optical Receiver mounted in one chassis with dual redundant power supply to be installed in porta cabin, required SFP optical device cartridges and standard accessories.
- 2.1.22. Bidder shall supply, install, test and commission (SITC) 3 sets of single-mode 24-core outdoor type Optical Fiber Cable between Optical Transmitter to be installed in old compression room and Optical Receiver to be installed in Porta Cabin, alongwith required Fiber Management system and standard accessories for four Compression chains (Two new and two existing).
- 2.1.23. Bidder shall supply, install, test and commission (SITC) 3 sets of single-mode 24-core outdoor type Optical Fiber Cable between Optical Transmitter to be installed in new compression room and Optical Receiver to be installed in Porta Cabin, alongwith required Fiber Management system and standard accessories for four existing Compression chains.
- 2.1.24. Bidder shall supply, lay IP cables with suitable connector from existing EPG and PSI/SI Generator/Server, IP data switch being used for IP streaming (Audio/Video Content, Data), NTP server to new compression system.
- 2.1.25. Bidder shall supply, install, test & commission (SITC) 8 sets of DVB-S and DVB-S2 compliant Modulators in (1+1) configuration including IF redundancy switch.
- 2.1.26. Bidder shall supply, install, test & commission (SITC) two sets of (1+1) Up-convertors system, RF redundancy switches and other accessories.
- 2.1.27. Bidder shall supply, install, test & commission (SITC) two sets of (1+1) (Ku Band) Klystron High Power Amplifiers (KHPAs), Ku band Diplexer, Automatic Dehydrator, Waveguide Switches, Waveguides, RF Equipment Control system and other accessories etc.
- 2.1.28. The bidder shall supply, install, test & commission (SITC) one set of RF NMS system comprising of (1+1) server and one client PCs with one client license for monitoring of RF chain of 2x(1+1) RF System of two Carrier and Satellite Modulator system in monitoring room.
- 2.1.29. Bidder shall supply, install, test & commission (SITC) Sub Distribution Boards (SDBs) fitted with industrial type MCCBs & MCBs in Old compression room and Monitoring Room for each source of power supply which caters the load of all new equipment in the respective room.

- 2.1.30. Bidder shall supply, install, test & commission (SITC) Power Supply cables (Minimum 70 Sqmm, 4 core copper Multi strand) between output of UPS PDPs to above said SDBs installed in Old compression room and Monitoring Room.
- 2.1.31. Bidder shall supply, install, test & commission (SITC) Sub Distribution Boards (SDBs) fitted with industrial type MCCBs & MCBs in Porta cabin for each source of power supply which caters the load of all new equipment (Except HPA) in the porta Cabin.
- 2.1.32. Bidder shall supply, install, test & commission (SITC) Power Supply cables (Minimum 70 Sqmm, 4 core copper Multi strand) between output of UPS PDPs to above said SDBs installed in Porta Cabin.
- 2.1.33. Bidder shall supply, install, test & commission (SITC) 1 set of 42 RU, 19", 1000mm (depth) equipment ventilated racks for installation of all offered equipment. The suggestive number of equipment racks is approx **18 (excluding HPA racks)** however may increase as per the solution offered. All the racks are to be provided with minimum two sets of Mains Distribution Units (MDUs), each having, inbuilt with MDU or external, dual input, single phase automatic power transfer/static switch connected between two sources of power supply routed through physically isolated routes. Please refer **DRG.No.10**.
- 2.1.34. Bidder shall supply, install, test & commission (SITC) cable trays (as per site requirement) on top of all equipment racks and as per approved layout of all equipment, all inter connecting cables (Audio/video, RF, power supply , control , data, earthing, sensor cables etc) shall be laid on cable tray and routed from top of racks.
- 2.1.35. The bidder shall provide minimum 8 sets of earth pits for this DTH set up. Please refer drawing no 12.
- 2.1.36. Bidder shall supply and install one set of measuring equipment as per BOM.
- 2.1.37. The bidder shall supply, install, test & commission (SITC) 1 set of 64x64 SD-SDI & HD-SDI/ASI compatible router with dual redundant power supply, X-Y remote panel and single Bus panel for confidence level monitoring.
- 2.1.38. Bidder shall supply, install, test & commission (SITC) 2 set of confidence level monitoring system.
- 2.1.39. Bidder shall supply, install, test & commission (SITC) 4 sets of multi-viewer display system (For monitoring of Input source, Ku band DD FreeDish Downlink signal). Each set of Multi Viewer display system shall display minimum 40 SDTV channels including 16 HDTV channels.
- 2.1.40. Bidder shall supply, install, test & commission (SITC) 4 nos., 55 inches (nominal) (diagonal) new LGD monitor with back-lit LED Based display system for monitoring of input TV & Radio sources and Ku band DD FREEDISH downlink signal.

- 2.1.41. Bidder shall supply, install, test & commission (SITC) 1 set of 16 Channel multi-viewer system for confidence monitoring of one channel of each eight carrier of Ku band DD FreeDish platform simultaneously in porta cabin.
- 2.1.42. Bidder shall provide furniture for installation of various offered monitoring equipment in monitoring and control room matching with existing furniture.

### 3. Work Experience for Vendor and OEMs

#### 3.1 Work Experience for Selection of the vendor:-

3.1.1 Bidder must have his local office/authorized representative/dealer in India for after sales service support.

3.1.2 The Bidder shall have to meet the following Work experience:-

Work Experience- (Self - certified with relevant documents*)-	<p>a. One Similar work** of minimum value of 80% of estimated cost of the project.</p> <p>or</p> <p>b. Two Similar works** of minimum value of 60% of the estimated cost of project,</p> <p>or</p> <p>c. Three Similar works** of minimum value of 40% of the estimated cost of project.</p>
---	--

Note:

- a) \*Self-certified with Relevant document means to provide copies of work order/orders clearly mentioning the cost of the project/projects and Receipt Certificate/successful completion certificate/Factory dispatch document/Delivery Challan/Copy of Invoice of the project/projects to various organizations along with the bid.
- b) \*\*Similar works will be defined based on scope of the work or SITC of Earth Station/Teleport for DTH/Digital Earth Station/DTT/DVB-C/VSAT/DSNG/IT Based Broadcasting Equipment (i.e. as a standalone or in combination of these works) in any past five financial years during the period 2016-2017 to 2022-2023. Similar Work may be executed with any Central and State Government agency, PSUs, Private organizations. Bidder shall provide list of all the self-certified relevant document of such work experience along with their cost in Rupees.

### 3.2 Eligibility criteria for OEM of Input and Baseband System:-

3.2.1.1 Bidder shall offer L band Router/Matrix of only those OEMs who are having past experience of at least five years of manufacturing and supplying of similar L band Router. List of past supply record of OEM of such equipment to various organizations must be provided.

3.2.1.2 OEM of the offered equipment must have manufactured and supplied the offered equipment to the leading broadcaster as mentioned in the table below in any past five financial years during the period 2016-2017 to 2022-2023:

S. No.	Offered Equipment	Qty
1	L band Router/Matrix	5 Nos.

3.2.1.3 Copies of supply order and receipt certificate/Factory dispatch document/delivery challan/Copy of invoice of above said quantity of L band Router/Matrix provided in para 3.2.1.2 to various organizations in any past five financial years during the period 2016-2017 to 2022-2023 should essentially be submitted along with the bid document.

### 3.3 Eligibility criteria for OEM of Compression System-

3.3.1.1 Bidder shall offer compression system of only those OEMs who are having past experience of at least five years of manufacturing and supplying of similar compression equipment. List of past supply record of OEM of such equipment to various organizations must be provided.

3.3.1.2

a) OEM of the offered equipment must have manufactured and supplied the offered equipment to the leading broadcaster as mentioned in the table below in any past five financial years during the period 2016-2017 to 2022-2023:

S. No.	Offered Equipment	Quantity
1	Professional IRDs	100 Nos.
2	IP Encapsulator	10 Nos.

b) OEM of the offered equipment must have manufactured and supplied the offered equipment to the leading broadcaster as mentioned in the table below in post year 2020.

S. No.	Offered Equipment	Quantity
1	Encoder Chassis*	12 Nos.

\*Out of 12 Nos of Encoder chassis, atleast 6 nos. of Encoder chassis should have been supplied for DTH/Earth Station compression system for Broadcast Purpose.

*Handwritten signatures and initials:* [Signature], [Signature], [Signature]

3.3.1.3. Copies of supply order and receipt certificate/Factory dispatch document/delivery challan/Copy of invoice in respect of above said quantity of professional IRDs and IP Encapsulators provided in para 3.3.1.2.(a) in any past five financial years during the period 2016-2017 to 2022-2023 and in respect of above said quantity of Encoders Chassis provided in para 3.3.1.2.(b) in post year 2020 to various organizations should essentially be submitted along with the bid document.

#### 3.4 Work Experience for OEM of IF & RF System ( Satellite Modulator, Upconverter, Down Converter, High Power Amplifier):-

3.4.1.1 Bidder shall offer RF system of only those OEMs who are having past experience of at least five years of manufacturing and supplying of similar RF System. List of past supply record of OEM of such equipment to various organizations must be provided.

3.4.1.2 OEM of the offered equipment must have manufactured and supplied the offered equipment to the leading broadcaster as mentioned in the table below in any past five financial years during the period 2016-2017 to 2022-2023:.

S. No.	Offered Equipment	Quantity
1	Satellite Modulator	10 Nos.
2	Ku band Upconverter	10 Nos.
3	Ku Band (Down link Frequency) to L band Down Converter	10 Nos.
4	Klystron High power amplifier (KHPA).	10 Nos.

3.4.1.3 Copies of supply order and receipt certificate/Factory dispatch document/delivery challan/Copy of invoice of above said quantity of equipment provided in para 3.4.1.2 to various organizations in any past five financial years during the period 2016-2017 to 2022-2023 should essentially be submitted along with the bid document.

#### 3.5 Eligibility criteria for OEM of Monitoring System-

3.5.1.1 Bidder shall offer Multi-viewer of only those OEMs who are having past experience of at least five years of manufacturing and supplying of similar Multi-viewer. List of past supply record of OEM of such equipment to various organizations must be provided.

3.5.1.2 OEM of the offered equipment must have manufactured and supplied the offered equipment to the leading broadcaster as mentioned in the table below in any past five financial years during the period 2016-2017 to 2022-2023:

S. No.	Offered Equipment	Quantity
1	Multi-viewer	10 Nos.

*(Handwritten signature)*

*(Handwritten signature)*

- 3.5.1.3 Copies of supply order and receipt certificate/Factory dispatch document/delivery challan/Copy of invoice of above said quantity of Multi Viewer provided in para 3.5.1.2 to various organizations in any past five financial years during the period 2016-2017 to 2022-2023 should essentially be submitted along with the bid document.
- 3.6 In addition to above said technical eligibility criteria, Vender/bidder shall also see and ensure to meet the commercial and Financial eligibility criteria pertaining to the a) company existence, b) Annual turnover/Net worth, c) Positive net worth/Profitability, d) Non-Blacklisting certificate, e) ISO certification (If required), f) GFR restrictions/Norms (if required), g) PMA and h) relaxation for Start-up as mentioned in the Appendix A, Appendix B & Appendix C of the bid document.
- 3.7 Bidder must have a valid Dealer Possession License (DPL) at the time of submission of bid. A copy of valid DPL should be submitted along with bid.
- 3.8 **For Consortium/Joint Venture ( If applicable):**
- In case of Consortium/Joint Venture, Vender/bidder shall follow the instructions provided at Appendix-A of the bid document.

#### 4. Turnkey Implementation and Commissioning

- a) The complete project will consist of Supply, Installation, Testing and Commissioning (SITC) of "Expansion of DD FreeDish platform by SITC of additional two Compression streams with two RF systems [8x(1+1) Modulator, 2x(1+1) KHPA system, 2x(1+1) up converters and other accessories] along with Diplexer at DD FreeDish Earth Station Todapur". The project will be carried out on turnkey basis.
- b) Each and every offered equipment and accessories including software should be from reputed manufacturer and the quoted model should be high class, high MTBF, field proven and in use by leading broadcasters/organizations.
- c) The system shall be designed to meet the international standards for digital satellite broadcasting known as the 4:2:0, MPEG-2, MP@ML & H.264/MPEG-4, MP@L3 for SDTV and 4:2:0, H.264/MPEG-4, MP@L4 & H.265/HEVC, MP@L4 for HDTV standards.
- d) The bidder has to comply with BIS (Bureau of Indian Standard) certification on invoke to all the offered equipment.

#### 4.1 Input and Base Band System:

- 4.1.1 L band output signal received from existing Receive Antenna through splitter will be connected to line amplifier at porta cabin and there after the output of Line amplifier will be connected with L Band Router in old compression room. The L Band Router in new compression room shall also be connected to L band Router to be installed in old compression room and finally L band signal shall be connected to all IRDs.
- 4.1.2 Bidder has to supply, lay, integrate and test RF cables with matching connectors as per DRG 1, 2 & 3.

#### 4.2 Compression System:

- 4.2.1 Bidder shall lay, integrate and test video cables with matching connectors from all IRDs of TV channel to SD/IID-SDI Input patch panels, SD/HD-SDI Input Patch Panels to SD/HD SDI Routers, Output of SD/HD SDI Routers to Output Patch Panels and finally upto the input of all Encoder chassis.
- 4.2.2 Bidder shall lay, integrate and test Audio cables with matching connectors from all Radio IRDs to the Input of AES patch panels, AES Patch Panels to AES Audio/Video Embedder; Video cables from AES Audio Embedder to SD/HD-SDI Input patch panels, SD/HD-SDI Input Patch Panels to SD/IID SDI Routers, Output of SD/HD SDI Routers to Output Patch Panels and finally upto the input of all Encoder chassis.
- 4.2.3 Professional IRDs for receiving TV channel and Radio Channel shall have same technical Specification and shall meet DD technical specification. The quantity of the Chassis for Professional IRDs may vary in the suggestive DRG. No. 2 & 3 as per offered solution by the successful bidder.
- 4.2.4 Bidder shall lay, integrate and test Ethernet cables with matching connectors from IRDs to (1+1) IP data switch & network switch and upto the input of all Encoder chassis. Further, Ethernet cables with matching connectors shall also be laid, integrate and test from the output of Encoder chassis to (1+1) IP data switch and upto the input of (1+1) IP Encapsulator of each sets.
- 4.2.5 There shall be two fully populated complete chassis of encoder as redundant for each stream. The number of encoders in the redundant chassis shall be populated with same or more number of encoders as in highest populated main encoder chassis.
- 4.2.6 Bidder shall integrate and test Ethernet cables with matching connectors from existing IP Router to EPG and PSI/SI Generator/Server and upto the IP data switches & network switches.
- 4.2.7 Bidder shall lay Ethernet cables and integrate newly supplied IP network switches with existing NTP server.

*[Handwritten signature]*

*[Handwritten signature]*

*[Handwritten signature]*

- 4.2.8 All the Electronic equipment should have necessary control interfaces through RS 232 / RS 422/ RS 485/ RJ45 etc so that they can be interfaced with a Control Computer for remote monitoring and control with suitable GUI. The associated software for logging, archiving, monitoring and controlling along with the accessories should also be made available.
- 4.2.9 For Integration of equipment, Indoor type Video Cable, Audio Cable, and CAT-6 or better cable for Audio/Video/IP data, IP networking should be used.
- 4.2.10 The system must offer an intuitive user interface as well as remote configuration of all modules, simplifying system deployment and reducing operational routines.

#### 4.3 Satellite Modulator system and IF redundancy switch:

- 4.3.1 Bidder shall supply, install, test & commission (SITC) DVB-S and DVB-S2 Modulators in 8x(1+1) configuration including IF redundancy switch. Please refer DRG. No. 6 & 6(A).
- 4.3.2 The offered system shall meet the International standards for digital satellite broadcasting having DVB-S and DVB-S2 modulation (one at a time).
- 4.3.3 The offered system would also include the standard accessories supplied by the Manufacturer along with the modulator and IF redundancy switch.
- 4.3.4 Cables are to be laid in Porta cabin from Satellite Modulators to IF patch panel and from IF patch panel to Up-converters rack and from Up-converter's rack to HPA racks for two chains.
- 4.3.5 Cables are to be laid in Porta cabin from Satellite Modulators to IF patch panel and from IF patch panel to Up-converters rack for existing six chains.

#### 4.4 RF System including Up converters RF redundancy switch and KHPA system:

- 4.4.1 Bidder shall supply, install, test & commission (SITC) 2x(1+1) KHPA system, 2x(1+1) Ku Band up converters, RF Redundancy switch and other accessories, associated waveguide and Power Supply System. Please refer DRG. No. 7.
- 4.4.2 The bidder shall integrate the offered RF System with the existing RF and uplink antenna system and commission it. Bidder has to offer the solution accordingly. Please refer DRG. No. 7.
- 4.4.3 The new KHPA systems are to be integrated with existing Uplink Antennae. (Refer DRG. No. 7).

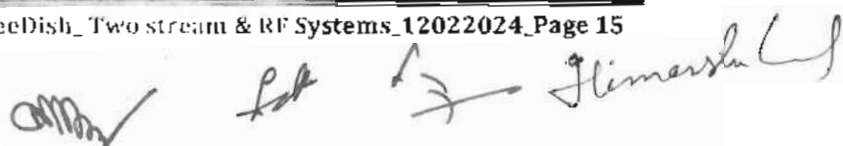
 The bottom of the page contains several handwritten signatures and initials in black ink. From left to right, there is a signature that appears to be 'AMM', followed by 'Lok', a signature that looks like 'S', and a large signature that reads 'Glimarshu'.



#### 4.5 Mains Distribution Unit and Power Supply system :

- 4.5.1 Bidder shall supply, install, test & commission (SITC) Sub Distribution Boards (SDBs) fitted with MCCBs & MCBs in old compression room and Monitoring Room for each source of power supply which caters the load of all new equipment in the respective room. Please refer DRG. No. 10.
- 4.5.2 Bidder shall supply, install, test & commission (SITC) Minimum two sets of Mains Distribution Units (MDUs), each having, dual input-single phase automatic power transfer/static switch either inbuilt with MDU or externally connected with MDU in each rack for providing redundant power supply to equipment. Please refer DRG. No. 10.
- 4.5.3 Bidder shall provide two separate sources of power supply in each rack through physically isolated routes and terminated on industrial type 3 Pin female connector to be mounted near each rack. Further, both source of power supply shall be connected to dual input static switch inbuilt with MDU or dual input external single phase automatic power transfer/static switch through industrial type 3 Pin male connector. In case of external static switch, the outputs of single phase automatic power transfer/static switch shall be connected to MDU for further feeding to equipment. Please refer DRG. No. 10.
- 4.5.4 Bidder shall supply, install, test & commission (SITC) Thermometers and Hygrometers with IP output in each rack for monitoring of temperature and humidity of each rack at monitoring room through remote monitoring system. Please refer DRG. No. 11.
- 4.5.5 Bidder shall assess the electrical load of equipment installed in each room, required length & rating of power supply cables. Bidder shall provide assorted length of copper power supply cables with minimum 50 percent (nominal) load margin for interconnecting/integrating from existing UPS Output PDPs to individual rooms, PDPs & SDBs etc Please refer DRG. No. 10.
- 4.5.6 The layout plan, electrical diagram, SDB layout, Rack layout, Interconnecting drawing of Equipment Drawing and other drawings need to be submitted for approval of Doordarshan before execution of SITC work at site.
- 4.5.7 The offer shall include supply, installation, testing and commissioning (SITC) of the setup, complete in all respects. A suggestive block schematic is provided to give a general idea about the intended configuration. A complete schematic of actually proposed implementation including power supply system should be supplied along with the quote.

#### 4.6 Monitoring and Measuring system

- 4.6.1 Bidder shall make provision for monitoring of Input/Source signals received from C - band receive PDA through IRDs i.e. IP Input (MPEG-2 TS over IP) compressed in MPEG-2, MPEG-4 & HEVC format need to be routed to

*[Handwritten signature]*

*[Handwritten signature]*

the input of multi-viewer. Dolby Digital (AC-3) 5.1 audio data with meta data are also embedded on to HD-SDI signal which shall be routed to multi viewer system for monitoring. In addition to above, Bidder shall also make provision for monitoring of Inputs/source signal of Radio service received from the output of AES Audio embedder i.e. carrying with SD/HD-SDI colour bar and routed to the input of Multi-viewer. (Please refer DRG. No. 9).

- 4.6.2 Bidder shall make provision for monitoring of DTH Downlink signals received from Ku- band receive PDAs need to be routed through chassis consisting of multiple DVB-S & DVB-S2 demodulators & CAS descramblers with MPEG-2 TS over IP output and MPEG-2, MPEG-4 & HEVC SD and HD decoders and it shall be routed to the input of multi viewer of monitoring system. MPEG-1 Layer-II and Dolby Digital (AC-3) 5.1 audio data with meta data are also embedded on to HD-SDI signal which shall be routed to multi viewer system for monitoring. (Please refer DRG. No. 9). There should be at least one chassis of demodulator & CAS descramblers for each stream.
- 4.6.3 There should be CI slot in downlink chain to demodulate DVB-S & DVB-S2 services and descramble (CAS) all MPEG-2, MPEG-4 & HEVC services of all streams. There shall be provision to demodulate & descramble (CAS) at least 40 TV service & 8 Radio channel per stream. CI slot is required to be provided in the downlink monitoring chain for CAM modules in demodulators/Descrambler or before decoders so that encrypted channels can be received. Each CAM module shall decrypt upto eight services.
- 4.6.4 Bidder shall supply, install, test & commission (SITC) four sets of multi-viewer display system for monitoring of TV Channels (Two sets for Input source and other Two sets for Monitoring of Ku band DTH Downlink signal). Each set of multi viewer display system shall be provisioned to decode and display 40 SDTV including 16 HDTV channels and 8 Radio channels.
- 4.6.5 The input source of signal shall be IP Input (MPEG-2 TS over IP, RTMP, HLS, SRT) compressed in MPEG-2, MPEG-4 & HEVC format. Ku band DTH down link signal shall be CAS encrypted MPEG-2 TS over IP with MPEG-2, MPEG-4 & HEVC compressed, DVB-S & DVB-S2 standard. (Please refer DRG. No. 9).
- 4.6.6 Bidder shall provide video cables connected between multi viewer systems to display system in Monitoring room.
- 4.6.7 Bidder shall supply, install, test & commission (SITC) 2 nos. of Ku- band receive PDA having size 120 cm and 2 nos. of Ku band receive PDA having size 60 cm for receiving the downlink signal for DTH downlink monitoring. These antennae shall be installed by making foundation on roof top of DD FreeDish Building.

amh / Loka / 7 / Himanshu C.

- 4.6.8 Bidder shall supply install, test & commission (SITC) of 2 sets of Computer Control system for Multi-viewer monitoring system. One set shall be used for Input source multi viewer monitoring and other set for down link multi viewer monitoring system.
- 4.6.9 The bidder shall supply, install, test & commission (SITC) 1 set of 64x64 SD-SDI & HD-SDI/ASI routers with redundant power supply with X-Y remote panel and single Bus panel (Please refer DRG. No. 8.)
- 4.6.10 Bidder shall supply, install, test & commission (SITC) 1 set of confidence level monitoring system including IRDs, 16.5 to 17 inch color monitor, Audio/Video Amplispeaker etc. There should be provision for monitoring points at the following locations:
- a. **Input Monitoring(SDI):** SDI (with Embedded audio in MPEG-1 Layer-II, Dolby Digital AC-3 5.1 Audio & Dolby Digital Plus 5.1 audio and metadata) from SDI Routers using 64x64 SD & HD-SDI/ASI Router, WFM, 16.5 to 17 inch colour monitor, 16 Channel Audio/Video Monitor with Amplispeaker (Refer DRG No. 2, 3 & 8). However, existing WFM shall be used.
  - b. **Input Monitoring (ASI & IP):** ASI Output of source IRDs through patch panel and its IP output through IP Switch, IRD (with ASI & IP input) and 64x64 SD & HD-SDI/ASI Router, using WFM and 16.5 to 17 inch Colour monitor, 16 Channel Audio/Video Monitor with Ampli speaker (Refer DRG No. 2, 3, & 8). However, existing WFM shall be used.
  - c. **Encoders Monitoring:** Output of encoder through IP Switch, IRD (with IP input) and 64x64 SD & HD-SDI/ASI Router, using WFM and 16.5 to 17 inch Colour monitor, 16 Channel Audio/Video Monitor with Ampli speaker (Refer DRG No. 2, 3 & 8). However, existing WFM shall be used.
  - d. **Multiplexers monitoring:** Multiplexer output through ASI router and IRD (with ASI input) and 64x64 SD & HD-SDI/ASI Router, using WFM & 16.5 to 17 inch Colour monitor, 16 Channel Audio/Video Monitor with Ampli speaker) (Refer DRG No. 2, 3 & 8). However, existing WFM shall be used.
  - e. **Modulator monitoring:** Modulator output monitoring through IF to L Band upconverter, using IRD and 16.5" to 17" colour Monitor in porta Cabin.
  - f. Temperature and humidity monitoring facility of each new equipment rack through remote computer.

#### 4.7 System Requirements:

- 4.7.1 The bidder must ensure completeness of the envisaged expansion of DTH set up in all respects. The envisaged DTH set up should be completed and fully wired for all the equipment fitted in 19" standard racks. The offered system must have enough flexibility in adapting the changing requirements from the technical and operational point of view. The bidder should submit detailed schematics and layouts for proposed solution based on the offered equipment along with the offer.
- 4.7.2 In order to ensure the completeness of the scope of system, any additional equipment/accessories which bidder feels necessary to complete the configuration should also be quoted. However, in such case they should provide proper justification for the additional equipment required.
- 4.7.3 Bidder shall submit only one solution (Single BOM) for the offered system. Bid with multiple options against any requirement is liable to be rejected. BOM shall not contain any optional items as an alternative for any line entry item. However, bidder can offer additional accessory items as options for performance improvement of main line entry item of same make.
- 4.7.4 Each offer should be complete in all respect. Incomplete & non-compliant offers will be rejected summarily, without making any references to bidder.
- 4.7.5 Bidder may have to demonstrate the features of equipment offered as and when asked as part of technical evaluation of tender including statistical multiplexing in MPEG-4/HEVC compression format for 32 SDTV/16 HDTV channels in full resolution per transport stream. However, it will not bestow any right of acceptance of the bid.
- 4.7.6 In the process of technical evaluation, Doordarshan may ask for any clarification/ query as required through e-mail/FAX/Post, which shall be treated as a part of tender and invariably attended and replied by the bidder within the time stipulated therein.
- 4.7.7 Cross reference in respect of supporting documents, should be given with proper page number and volume no. etc. If required Doordarshan may also ask for any other supporting document to ascertain the claim of bidder and their OEM.
- 4.7.8 All software being offered, are to be licensed to Doordarshan on perpetual basis without specifying any time limit or without specifying any end of life of the software. Software upgrades within five years of installation i.e. warrantee period should be supplied free of cost.
- 4.7.9 The bidders may visit the site for their assessment of existing facilities and requirement before submission of the bid. Bidders desiring to visit the site must submit the request to Doordarshan in one week advance with the details of the persons for facilitating the visit.

- 4.7.10 Cost of any other work, consultancy and material required for completing the installation & commissioning of the Input Baseband System, Compression System, Monitoring System and RF System including power supply system should be taken into account and clearly mentioned while submitting the tender.
- 4.7.11 The local office/authorized representative/dealer will be nodal point for resolving issues, related to installation, commissioning and after sales service support. Details of OEM office and its location are to be provided along with bid.
- 4.7.12 The offer should clearly specify the list of equipment hardware, interfaces, cables etc and associated software provided with the Remote Computer System for interfacing it with different components of the chain.
- 4.7.13 To avoid any delay due to inter-dependent activities like site readiness, providing power supply etc, The bidder should submit time frame for completing the activities up to the commissioning of the set-up on a PERT chart starting from date of issue of Purchase Order (P.O.) ( i.e. DD/MM/YYYY) along with bid.
- 4.7.14 As an SITC contract, all supplied equipment are to be installed, tested and commissioned at site mentioned above, by the Bidder. The cost of any other interconnecting material and labour required for laying of cables, Earthing etc. should be included in the tender.
- 4.7.15 The successful bidder will be solely responsible for commissioning and operationalisation of the Input and Baseband System, Compression System, Monitoring System, RF System and Power Supply System to the satisfaction of Doordarshan.
- 4.7.16 Suitable assorted items required for the project like RF cables with connectors (N type, Male & Female), terminations, Bullets N type, RF splitter, RF combiners etc, interconnecting material including any other cables and connectors etc are to be offered by the bidder.
- 4.7.17 The successful bidder shall prepare and submit the final system design within 30 days of issue of A/T as per the site condition in consultation with Doordarshan and get it approved by Directorate General, Doordarshan before actual implementation.
- 4.7.18 The successful bidder will be required to print and display the Final laminated Technical Block diagram and detailed Line diagrams (in color) of adequate (A1 or bigger) size for all the modules of the final solution in the facility after the completion of the installation. One set shall be mounted on wall and other for record at Station. The soft editable copy of the Technical Block diagram and detailed Line diagrams (in color) shall also be provided.

Handwritten signatures and initials at the bottom of the page, including a signature that appears to be 'Srinivasan' and other initials.

- 4.7.19 System/equipment (motor controllers etc.) should be offered along with its frame/housing and other accessories which are necessary to meet the specifications/requirement and for the full exploitation of the equipment.
- 4.7.20 The routing of wiring between racks to be done from the Top of the racks.
- 4.7.21 The bidder should specify the hardware limitation if any.
- 4.7.22 The system must offer an intuitive user interface as well as remote configuration of all modules, simplifying system deployment and reducing operational routines.
- 4.7.23 A suggestive block schematic is provided in annexure –VII of Appendix-D to explain the full scope of the work and give a general idea about the intended configuration. A complete schematic of actually proposed implementation should be supplied along with the quote. Physical topography may be different than the suggestive block diagram but it should meet the project objectives.
- 4.7.24 The layout plan of equipment of Input and Base band system, Compression system and Monitoring system, RF system, Power Supply System, racks, electrical diagram, PDP, SDB layout and other drawings need to be submitted for approval of Doordarshan before execution of SITC work at site.
- 4.7.25 The system offered should be complete in all respect.

## 5. Technical Specification of Major Equipment

### 5.1 Specification for Input and Base band System

L band output signal received from existing Receive Antenna through splitter will be connected to line amplifier at Porta cabin and thereafter, the output of Line amplifier will be connected with L Band Router in old compression room. The L Band Router in new compression room shall also be connected to L band Router to be installed in old compression room and finally L band signal shall be connected to all IRDs. Further, Low loss cable is to be supplied and laid for connecting L band signal from porta cabin to old compression room, existing L Band Router installed in old Compression Room to L Band Router and as per site requirement. The major equipment of input and base band system will consist of:

- (a) Dual/ Single Channel L Band Line Amplifier
- (b) 64x192 L Band Router
- (c) IRD's for SD & HD and Radio channels
- (d) 8 AES Audio Digital & SDI Video Embedder

*amb* *Feb* *Jimarshu*

### 5.1.1 Dual/single Channel L Band Line Amplifier

#### A. General

1. The L-Band Line amplifier will be used for transporting RF Satellite signals in the L Band from porta cabin to the L band router panel located in old Compression room; and old Compression room to new Compression room.
2. The offered solution should be scalable and modular in design and architecture. The offered system should have space for future expansion by adding additional modules.
3. The system should have built-in 1:1 dual redundant & hot-swappable power supply units.
4. L band Line Amplifier shall be configurable locally through front-panel or remotely via Web-Interface (Web-GUI, SNMP etc).
5. It should have comprehensive LED indicators on amplifier module and/or LCD display panel on chassis for status information like LNB voltage and DC input voltage level etc.
6. L band line Amplifier should support RF Power monitoring OR its status monitoring through NMS of L-band Input system.
7. The system may have minimum 4 slots per chassis and 19" rack-mount.

#### B. Technical Specification

S. No.	Parameter	Specification
1	RF Input Connector	BNC/F-Type, Female,
2	No of RF Input Port	Minimum one no. for each channel
3	RF Input Impedance	75Ω
4	Input Frequency Range	950 MHz to 2150 MHz
5	RF Input Power Level Range	-10 to -60 dBm
6	RF input power level (Max)	(+) 3dBm max. (damage level)
7	Input Return Loss	12 dB min
8	Output frequency response	±1.5dB max at 0dBm RF Output
9	Output Gain Control	MGC and AGC selectable
10	Gain Range	25 dB Min in 1 dB step
11	Switchable LNB-supply	13V, 18V, OFF (Selectable) DC, 22kHz tone, 400mA min
12	Protection	Short Circuit, Current Limited

*Handwritten signatures and initials:*  
 [Signature] [Initials] [Signature]

### 5.1.2 L-Band Router (64 x 192) with control panel

#### A. General

- (i) L band signal shall be received from Existing 64 X 192 L band Router (main and Standby) installed in new Compression Room and from 1:4 RF splitters to be installed in old Compression Room The output of L band router shall be connected to IRDs.
- (ii) Router should have Full fan out (splitting) facility such that it can be configured to route any of the input (64 input) carrying L band signal to any or all of the output (192 no. outputs).
- (iii) It should have hot swappable dual redundant Power supply unit.
- (iv) It should have hot swappable frame controller card or CPU Card.
- (v) It should have Cross point Matrix module or Mid Matrix Card or Central Switch Board.
- (vi) It should have hot swappable Input cards and hot swappable Output cards.
- (vii) The unit shall be able to provide DC power to LNBs either through inbuilt power supply or external power supply unit of the same make as of router.
- (viii) The matrix should be modular and scalable to future expansion upto (64 x 256) as and when required.
- (ix) The control of the L-band router (LBR) should be through OEM (Router) supplied NMS apart from the manual control & configuration through external control panel or control panel on router or front panel touch screen panel.

#### B. Technical Specification

Sl.	Parameter	Specification
1	Operating frequency	950 to 2150 MHz
2	<b>Isolation</b>	
a	Input to input	60dB (min.)
b	Output to output	60 dB (min.)
c	Input to output	50 dB (min.)
3	<b>Return loss</b>	
a	Input return loss	10 dB (min.)
b	Output return loss	10 dB (min.)
4	Input/output RF Connector	Type "F/BNC"
5	Impedance	75 ohm
6	Remote control	RS 232 or RS422/485 or RJ45 or other

*[Handwritten signatures and initials]*



### 5.1.3 Specification for Integrated Receiver Decoder (IRD)

#### A. General

- (i) The professional IRDs should receive the L band input and give digital (SD-SDI, SD-SDI with Embedded Audio, AES/EBU, HD-SDI, HD-SDI with Embedded Audio), ASI outputs and MPEG-2 TS over IP output with multiple services filtering facility and bulk decryption.
- (ii) One SD-SDI down converted output of HD-SDI should be available.
- (iii) IRD should be able to carry out multiple services filtering on IP output port.
- (iv) IRD should have provision to enter or edit all the parameters for perfect reception of the signals through either front control panel display or web browser.
- (v) There shall be a provision for observing BER & signal level or C/N & C/N margin or Eb/No & Link Margin for DVB-S mode of operation and PER & signal level or C/N & C/N margin or Es/No & Link Margin for DVB-S2 mode of operation through either front control panel display or web browser.
- (vi) IRD should be able to bulk descramble BISS mode 1 and BISS-E signals.
- (vii) There should be at least one vacant slot (CI slot) for each channel of conditional Access System for descrambling all MPEG-2, H.264/MPEG 4 & H.265/HEVC encoded channel and DVB-S & DVB S2 compliant services. Each CI slot should be integrated/configured with at least two L band Input port.
- (viii) There should be direct decompression of ASI to SDI i.e. not through analog to Digital conversion.
- (ix) IRD should be able to store at least 10 presets channels configuration in memory.
- (x) It should be possible to configure and monitor the IRD through NMS of compression system.
- (xi) IRD should be able to generate and save log for alarms and warning through NMS of compression system.
- (xii) IRD should have facility to pass ancillary data like closed captioning, EIA 608/708, DVB-Teletext, DVB- subtitle, DPI SCTE-35 etc.
- (xiii) Bidder may offer Server based professional IRDs in place of Hardware based professional IRDs. Each server chassis may accommodate two to four professional IRDs.

*[Handwritten signature]*

*[Handwritten signature]*

- (xiv) In case of server based professional IRD, either External or Internal Audio De-embedder shall be integrated with server based professional IRDs for taking Digital Audio Outputs (AES/EBU) mentioned under DD specs clause No. 5.1.3.F.

#### B. RF Parameter Specifications

Sl. No.	Parameters	Specification
1	Input Frequency Range	950 - 2150 MHz
2	No. of Inputs	2 (min.)
3	Tuning Step Size	125 kHz, Max.
4	Satellite Frequency Band	C- Band & Ku-Band, Selectable
5	Input Impedance	75 Ohms
6	Input Connector	F-Type female
7	Input Power Range	-30 to -60 dBm per carrier
8	Image Rejection	>30 dB
9	Input Return Loss	9 dB Min.
10	Noise Figure	15 dB Max.
11	AFC Tuning Range	$\pm 5$ MHz
12	De-Modulation Method	DVB-S QPSK, DVB-S2 QPSK and 8PSK
13	Variable Symbol Rates	1.0 to 40 M Symbol /sec for ( DVB-S) 1.0 to 40 M Symbol /sec for (DVB-S2)
14	Convolution Inner FEC selectable	R=1/2, 2/3, 3/4, 5/6,7/8 (DVB-S, QPSK), R=1/2, 3/5, 2/3, 3/4, 4/5,5/6, 8/9, 9/10 (For DVB-S2, QPSK) R= 3/5, 2/3 , 3/4, 5/6,8/9,9/10 ( DVB-S2 , 8PSK)
15	IF Filter Bandwidth	Automatic Selection (dependent on Symbol Rate).

#### C. ASI Input and ASI Output Transport Stream specification

Sl. No.	Parameters	Specification
<b>A ASI Input</b>		
1	Format	MPEG-2 TS over ASI on BNC
2	Quantity for ASI Input	Minimum one no. on BNC
<b>B ASI Output</b>		
1	Format	MPEG-2 TS over ASI on BNC
2	Quantity for ASI Output	Minimum one no. on BNC

**D. Audio and Video Decompression Parameters**

Sl. No.	Parameters	Specification
1	Video Resolution (all resolutions shall be capable of I, P & B frame decoding, other standard solution should be selectable)	i) For SDTV 720 X 576 544 X 576 480 X 576 ii) For HDTV 1920x1080 1440x1080
2	Video Decompression Type	i) SD MPEG-2, MP@ML, 4:2:0 ii) SD MPEG-2, 422@ML, 4:2:2 iii) SD MPEG-4, MP@L3, 4:2:0 iv) SD MPEG-4, Hi422@L3, 4:2:2 v) HD H.264 MP@Level 4.0 4:2:0 vi) HD H.264 Hi422 @ Level 4.0, 4:2:2 vii) HD H.265/HEVC Main 10 4:2:0
3	Television Standard	PAL-B (EN50083-9)
4	Audio Decompression Type	i) MPEG-1 Layer-II audio ii) HE AAC( MPEG 4) v1 & v2 5.1 Audio iii) Dolby Digital (AC-3) 5.1 Audio iv) Dolby Digital plus 5.1 Audio (E-AC-3) (Pass through) v) Linear PCM (Pass Through) vi) Dolby E (Pass-through)

**E. Digital Video output Specifications (SD-SDI & HD-SDI)**

Sl. No.	Parameters	Specification
1	SD-SDI and HD-SDI O/P Serial Interface	SMPTE 259M-(10 bit) 270 Mbps SMPTE 292M-1485 Mbps
2	SD-SDI with Embedded Audio	SMPTE 272M
3	HD-SDI with Embedded Audio	SMPTE 299 M
4	Video Output Format	HD-SDI and SD-SDI
5	Connector Type	BNC (75 Ohms)
6	Quantity	Minimum 2 Nos. of digital output compliant to ITU-R BT.656 Standard or latest
7	Level	800mV p-p for SDI As per ITU-R BT.601 (part A) and ITU-R BT.709

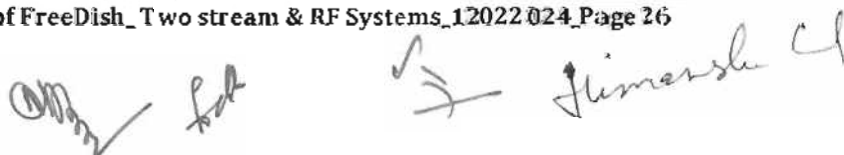

**F. Digital Audio Output Specifications:-**

Sl. No.	Parameters	Specification
1	Output Format	i) AES/EBU or AES3 id ii) HE AAC( MPEG 4) v1 & v2 5.1 Audio iii)Dolby Digital (AC-3) 5.1 Audio iv) Dolby Digital Plus 5.1 Audio (E-AC-3) (Pass- through) v) Linear PCM (Pass Through) vi) Dolby E (Pass-through)
2	Load Impedance	75/110 Ohms
3	Connector Type	BNC Female / XLR male Socket or with suitable XLR adapter (i.e. no terminal block)
4	Number of Output	4 Stereo Channels

**G. LNB Power Supply & Control**

Sl. No.	Parameters	Specification
1	LNB Voltage	+ 13 V (Vertical) and 18 V (Horz) polarizations switching or 19 V fixed.
2	LNB Power consumption (Current) capacity	300 mA or better
3	Over Current and short circuit protection	Fold back current limiting.
4	LNB Power Supply & Control	Receive Polarization Control by electrical Command Via LNB-IF feeder (High & Low band switching Pulse for Ku-Band operation).

**H. IP Input (TS & Data) and IP Output (TS & Data) specification**

Sl. No.	Parameters	Specification
<b>A</b>	<b>IP Input</b>	
1	Format	MPEG-2 TS over IP (MPTS & SPTS) on Ethernet
2	Quantity for IP Input	Minimum two nos. RJ 45 if Uni-directional ports OR Minimum one no. RJ 45 if Bi-directional port

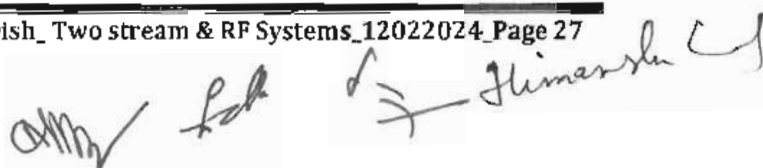

<b>B</b>	<b>IP Output</b>	
1	Format	MPEG-2 TS over IP on Ethernet with multiple services filtering facility and decryption.
2	Quantity for IP Output	Minimum two nos. RJ 45 if Uni-directional ports OR Minimum one no RJ 45 if Bi-directional port

**I. Size**

<b>Sl. No.</b>	<b>Parameters</b>	<b>Specification</b>
1	Mount	19" Rack Mount

**J. Hardware of Server in case of Server Based Professional IRDs**

<b>(a)</b>	<b>General Feature:</b>
i	Bidder may offer server based professional IRDs in place of Hardware based professional IRDs. Each Chassis may accommodate two to four professional IRDs.
ii	CPU/Chipset of server should have facility to enable an environment where applications can run within their own space, protected from all other software on the system.
iii	CPU/Chipset of server should have security feature that can reduce exposure to viruses and malicious-code attacks and prevent harmful software from executing and propagating on the server or network.
iv	CPU/Chipset of server should have facility of Secure Key consisting of a digital random number generator that creates truly random numbers to strengthen encryption algorithms.
v	CPU/Chipset of server should have Thermal Monitoring facility to protect the processor package and the system from thermal failure.
vi	The offered processor of server should be scalable, high quality, robust with efficient performance.
vii	Each server of software based professional IRDs should be designed with 85 percent (Max.) CPU loading.
viii	CPU of server shall be similar to Intel Xeon Gold series or better and launch date of CPU of server should not be prior to year 2020.
ix	Facility to store the last configuration in the software based professional IRDs.

(b) Hardware Feature:		
S. No.	Parameter	Specification
<b>A. Performance of Central Processing Unit</b>		
1	No. of Core	18 (Min.) per CPU
2	No. of Thread	36 ( Min.) per CPU
3	Processor Base Frequency	2.10 GHz or better
4	No. of CPU	Two or more
<b>B. Memory Specification</b>		
5	RAM	DDR4, 64 GB or more
6	Storage Memory	SSD, 240 GB (Min.) in Raid 1 Configuration
<b>C. Operating System</b>		
7	Operating System	Linux
<b>D. Ethernet Network</b>		
8	No. of Ports (Duplex) in Server	i. Minimum one physical (RJ 45) bi-directional port of 1 Gigabit for Input ii. Minimum two physical (RJ 45) bi-directional port of 1 Gigabit for output iii. Minimum one physical (RJ 45) bi-directional port of 1 Gigabit for Management & Control
<b>E. PCI slot</b>		
9	PCI slot	2 nos. or more
<b>F. Operating Environment</b>		
10	Operating Temperature	10 to +35 °C
11	Humidity	10% to 90% non-condensing

#### 5.1.4 Specifications for 8 AES Digital Audio & SDI Video Multiplexer Unit (Embedder) for Radio Service

##### A. General

- 1) The offered product should auto detect the defined standard of video input signal.
- 2) It should be able to provide programmable audio delay for lip sync issues.
- 3) The offered Embedder should have excellent performance features like "high Input impedance", "flat frequency response", "very low total harmonic distortion" and "extremely high signal to noise ratio (S/N)".
- 4) It should be able to remove all available audio before embedding or allow overwriting.

*Handwritten signatures and initials:*  
 [Signature] [Initials] [Signature]

- 5) It should be able to embed AES on output without video source or genlock i.e. on Internal Colour bar.
- 6) It should be able to provide high quality cable equalization to the input signal up to the length of minimum 100 m @1.5 Gb/s & 250 m @270 Mb/s cable.
- 7) Monitoring software should allow configuration and status of the card.
- 8) Visual indicators should also give its status about power supply, input etc.
- 9) 19" rack Frame with Frame controller for remote configuration & monitoring; and auto switchable dual redundant power supply unit. Upto Two Audio embedder card shall be fitted in each Frame.

#### B. Technical Specifications

(a) Input:		
i.	Digital Audio Inputs	: AES3
ii.	No. of Audio Input	: 8
iii.	Connector type	: DIN/BNC/XLR with suitable adapter
iv.	Impedance	: 110 Ohm balanced
v.	Serial digital video Input	: 1 no. HD/SD-SDI& Internal colour bar
vi.	No. of Outputs	: 2 or more HD/SD-SDI signal with Embedded audio
vii.	Serial input & output return loss	: > 10 dB up to 3 GHz

#### 5.1.5 Specification for the Low loss cable :-

Low loss cable is to be supplied for connecting L band signal from L Band Router installed in New compression Room to L Band Router to be installed in old compression Room, porta cabin to old compression room, and as per site and project requirement for other places where required length is more than 30 m. The cable should have 75 ohm impedance and Attenuation (dB / 100 meter) at different frequencies as below –

Sl. No.	Operating Frequency (in MHz)	Maximum Attenuation of Cable up to (dB/100meters)
1	100	4.5
2	200	6.5
3	500	10.5
4	1000	15.0
5	1400	17.6
6	1800	20.0
7	2150	22.0

*(Handwritten signatures and initials)*

### 5.1.6 Specification for the Low loss cable for rack wiring:-

Low loss cable is to be supplied for connecting L band signal from, L band Router to IRDs, existing L Band Router installed in old Compression Room to L Band Router and as per site and project requirement for rack wiring. The cable should have 75 ohm impedance and Attenuation (dB / 100 meter) at different frequencies as below –

Sl. No.	Operating Frequency (in MHz)	Maximum Attenuation of Cable up to (dB/100meters)
1	135	12.8
2	180	14.5
3	270	17.9
4	1000	35.8
5	1500	44.5
6	2000	53.5

## 5.2 Digital Compression System

- i) The baseband and MPEG 2 TS over IP signals to the Input of the Encoders are to be brought from IRDs installed in Input rack via SDI Router & IP Data Switch. All the compression equipment should preferably be from one OEM/company or approved by OEM of compression system, for ease of operation, networking and full automation. The system management should be through NMS. The compression system shall comprise basically a minimum of the following equipment:
  - a) 64x64 SD/HD-SDI Routing Switcher.
  - b) Chassis consisting of multiple MPEG-2 & MPEG-4 SDTV and MPEG-4 & HEVC HDTV Video Encoder.
  - c) IP Encapsulator cum Multiplexer for Statistical Multiplexing with DVB-CSA (V-1 & V-2) supported DVB-CAS(CAS) simulcrypt encryption.
  - d) IP Data Switch.
  - e) Compression Control system Computer (Hardware and Software) i.e. Network Management System (NMS).
  - f) 16 x 16 or better matrix of SDI/ASI Router.
  - g) 3G/HD/SD SDI, DVB/ASI Compliant (1 x N) Distribution Amplifier system.
  - h) OFC system for receiving MPEG-2 TS over IP of each existing four Compression chains from new Compression Chain room to Portacabin.

*[Handwritten signatures and initials]*



- i) OFC system for receiving MPEG-2 TS over IP of each existing two and new two Compression chains from new Compression Chain room to Portacabin
- ii) The compression system should have facility to insert Logo (JPEG/PNG, GIF format) for each channel either in encoder or in multiplexer. Alternatively, separate logo inserter unit can also be offered.
- iii) All the Compression equipment like SDI Router, Encoders and IP Encapsulator cum Multiplexer, IP Switches, ASI Router etc shall be compatible with IP based interface.
- iv) All the Electronic equipment should have necessary control interfaces through RS 232 / RS 422/ RS 485/ RJ45 etc so that they can be interfaced with a Control Computer for remote monitoring and control with suitable GUI. The associated software for logging, archiving, monitoring and controlling along with the accessories should also be made available.

### 5.2.1 Specification for 64 x 64 SD/HD-SDI Routing Switcher

#### A. General:

The routing Switcher should be very reliable and able to be used for selection of any one of the 64 HD-SDI input signals to 64 HD-SDI different destinations. All 64 x 64 input and destinations shall also be SD-SDI. The equipment so offered should be for professional set-up applications. The Router has to be quoted with X-Y and Single Bus Remote Control Panels.

#### B. Essential features:

- (i) The routing switcher electronics should be capable of being mounted in a standard 19" rack frame.
- (ii) The rack frame should be modular to house input, output, control and power supply modules.
- (iii) The switcher shall handle HD-SDI & HD-SDI with embedded audio, SD-SDI & SD-SDI with embedded audio and ASI signal for routing from input to output destinations of their respective port. The switching should take place during the vertical interval period.
- (iv) The switcher should have storage facilities for control information, so that in case of power supply failure, the status of the switcher output should remain unchanged when the power supply is restored.
- (v) The switcher should have redundant cross point card/module and redundant controller/ logic cards to achieve complete (1+1) redundancy.

- (vi) The switcher should have auto-switchable redundant dual power supplies.
- (vii) A certificate from Compression OEM regarding compatibility with compression NMS is required to be submitted for offered router along with the bid.
- (viii) Any of the 64 HD-SDI and SD-SDI input shall be capable of being switched to any or all of 64 outputs port.

### C. Technical Specification:

Sl. No.	Parameter	Specification
1	Matrix size	64 x 64 for HD-SDI and SD-SDI port
2	Input and Connector	HD-SDI with embedded audio (including Dolby AC-3 5.1 audio & Dolby E, SD-SDI with embedded audio, and ASI ( BNC/HD BNC; 75 ohms)
3	Equalization for SD-SDI signal	Automatic; 150 Meters at 270 Mbps.
4	Equalization for HD-SDI signal	Automatic; 80 Meters at 1.485 Gbps.
5	Output and Connector	One or more HD-SDI with embedded audio (including Dolby AC-3 5.1 audio & Dolby E) and SD-SDI with embedded audio for each of 64 HD & SD SDI destinations; (BNC/HD BNC; 75Ω, 800 mV±10%)
6	Return Loss	≥10 dB on data rate upto 1485 Mb/s throughout the switching chain.

### 5.2.2 Specification for SDTV Encoder in MPEG-2 & H.264/MPEG-4-AVC Compression and HDTV Encoder in H.264/MPEG-4-AVC & H.265/HEVC Compression Configuration.

#### A. Configuration of Encoding System:

- (i) Bidder shall supply, install, test and commission (SITC) 2 sets of compression system having H.264/MPEG-4 and H.265/HEVC compliant Encoders in (X+2) chassis configuration where "X" is no. of chassis comprising of atleast 16HDTV Encoders with SDI input per stream. "X" no. of these encoder chassis shall also be capable to take atleast 40 SDTV signal with SDI input and compress them to MPEG-2 and H.264/MPEG-4 compression format without any limitation or requiring upgradation /downgrading by way of hardware and software. Each encoder chassis shall have 4 to 10 BNC/HD BNC/Micro BNC/DIN/Mini DIN Female ports enabled for feeding SD/HD SDI input signal. Each encoder chassis should have same hardware and software licenses.

*[Handwritten signatures and initials]*

For example, if bidder offers encoder chassis with 10 BNC/ HD BNC/Micro BNC/DIN/Mini DIN Female port, the probable combination/configuration of channels to be compressed in each chassis are tabulated below:

Groups/ Combinations (at a time anyone)	No. of BNC/ HD BNC/Micro BNC/DIN/ Mini DIN Female Ports enabled per chassis	No. of SDTV Channel to be compressed in MPEG-2 & H.264/MPEG-4 (at a time anyone standard) with SDI Input	No. of HDTV Channel to be compressed in H.264/MPEG-4 & H.265/HEVC (at a time anyone standard) with SDI Input	Total No of TV channels to be compress ed in Each chassis
(a)	10	10	0	10
(b)	10	9	1	10
(c)	10	8	2	10
(d)	10	6	4	10

- (ii) All the above encoder chassis of compression system shall also be capable to take MPEG-2 TS over IP input with decoding of MPEG-2, H.264/MPEG-4-AVC and H.265/HEVC Main 10 compressed contents to base band signal format. All encoder chassis with MPEG-2 TS over IP input shall be capable to encode minimum 4 HDTV channel in H.264/MPEG-4-AVC & H.265/HEVC Main 10 (at a time anyone standard) and minimum 16 SDTV channel in MPEG-2 & H.264/MPEG-4 (at a time anyone standard) without any limitation or requiring upgradation/downgrading by way of hardware and software licenses.

The probable combination/configuration of channels to be compressed by enabling various filters (Noise Filters, Pre-processing, etc) are tabulated below:

Groups/ Combinations (at a time anyone)	No. of SDTV Channels to be compressed in MPEG-2 & H.264/MPEG-4 (at a time anyone standard with MPEG-2 TS over IP Input)	No. of HDTV Channels to be compressed in H.264/MPEG-4 & H.265/HEVC (at a time anyone standard with MPEG-2 TS over IP Input)	Total No of TV channels to be compressed in each chassis
(a)	16	0	16
(b)	13	1	14
(c)	9	2	11
(d)	6	3	9
(e)	4	4	8

- (iii) Further, offered Encoder shall also be configurable to encode SDI & IP inputs simultaneously. The probable combination/configuration of channels to be compressed by enabling various filters (Noise Filters, Pre-processing, etc) are tabulated below:

Group/Combination of SDI and IP Input (at a time anyone)	No. of SDTV Channel to be compressed in MPEG-2 & H.264/MPEG-4 (at a time anyone standard) with SDI Input	No. of HDTV Channel to be compressed in H.264/MPEG-4 & H.265/HEVC (at a time anyone standard) with SDI Input	No. of SDTV Channels to be compressed in H.264/MPEG-4 (at a time anyone standard with MPEG-2 TS over IP Input)	No. of HDTV Channels to be compressed in H.264/MPEG-4 & H.265/HEVC (at a time anyone standard with MPEG-2 TS over IP Input)	Total No of TV channels to be compressed in Each chassis
(a)	10	0	6	0	16
(b)	8	0	8	0	16
(c)	6	1	2	1	10
(d)	2	2	2	2	8
(e)	0	4	4	0	8
(f)	4	0	0	4	8

#### B. Features of Encoder

- (i) There should be dual redundant SMPS power supply units per Chassis. In case of Single power supply unit in encoder chassis, bidders can offer additional chassis which shall be populated with same no. of encoders with single power supply unit for the completeness of the offer as an alternative to inbuilt redundant power supply unit.
- (ii) It should also have the preprocessing facility for the efficient encoding process viz; adaptive noise reduction.
- (iii) It should have multi-pass encoding.
- (iv) It should have interface for Remote Control.
- (v) It should generate PSI.
- (vi) On loss of Video input, it should have option to auto switch to pre-recorded Image (JPEG/PNG, GIF format) and in case of "No video Input", it should be configurable to "No video output".
- (vii) The encoder shall be MPEG-2, MPEG-4 and HEVC standard compliant without any limitation or upgradation by way of hardware or software licenses.
- (viii) There should be provision for 4 stereo audio with MPEG-1 Layer-1 & HE AAC v1 & v2 5.1 audio encoding in each SDTV encoder.

*(Handwritten signatures and initials)*

- (ix) There should be provision for 4 stereo audio with Dolby Digital (AC-3) 5.1 decoding & encoding, Dolby Digital plus 5.1 decoding & encoding, MPEG-1 Layer-II & HE AAC v1 & v2 5.1 audio encoding in each HDTV encoder which may enable to encode the audio in Dolby Digital (AC-3) 5.1 and Dolby Digital Plus 5.1 audio with down-mix of one MPEG-1 Layer-II at any given point of time.
- (x) There should be audio loudness control in each channel for maintaining uniform audio level in spite of changes from different input feeds and programs meeting the ITU-BS-1770-2/ITU-BS-1770-3 standard for loudness control.
- (xi) The Encoder shall be closed captioning compliant with EIA 608/708, DVB-subtitling and digital program insertion compliant with SCTE35 insertion via SCTE104 triggers without any limitation or upgradation by way of hardware or software licenses.
- (xii) The encoded output of chassis should be MPEG-2 TS over IP on RJ45 connector.
- (xiii) Encoder hardware/Server shall decode RTMP, HLS, SRT & ZIXI IP Input stream of TV and Radio Services in various format as mentioned below under clause "F" and these services shall be re-encoded; and encapsulated in the output of transport stream by IP Encapsulator cum Multiplexer. In addition to above, Encoder hardware/Server shall also be capable for encoding/streaming of TV & Radio services in RTMP, DASH, HLS format, so that it may be enabled by additional licenses in future, if required.
- (xiv) There should be provision for internal de-embedding of 8 AES audio channel from SDI input and thereafter these de-embedded 8 AES audio channel shall be encoded and configured to 8 Radio channel in each encoder chassis.
- (xv) Audio licenses provisioned for TV Channels shall be capable to encode Radio Channels without any limitation or upgradation by way of hardware or software licenses.

### C. Serial Digital Interface (SDI) Input Specifications

Sl.No.	Parameter	Specification
1	Video Inputs	SD-SDI & HD-SDI with embedded audio
2	Serial Interface	i) SMPTE 292M, 1485 Mb/s (10 bit) with embedded audio ii) SMPTE 259M, 270 Mb/s (10 bit) with embedded audio
3	Format	ITU(R)-BT. 601 & ITU-R BT.709

*[Handwritten signature]*

*[Handwritten signature]*

4	Connector	BNC/HD BNC/Micro BNC/DIN/Mini DIN Female,75 ohm
5	Physical SDI Port enabled	i) Minimum 4 Port ii) Maximum 10 Port
6	Input Level	800 mV p-p nominal $\pm 10\%$ , SDI input
7	Return Loss	$\geq 15$ dB from 5 MHz to 1.5 GHz /OR $\geq 10$ dB on data rate upto 1485 Mbps

#### D. Embedded Serial Digital Audio Input Specifications

Sl. No.	Parameter	Specification
1	Serial interface	a) SMPTE 272M b) SMPTE 299M
2	Format	AES/EBU, 4 stereo channels
3	Connector	BNC/HD BNC/Micro BNC/DIN/Mini DIN Female,75 ohm

#### E. IP Transport Stream Input Specifications

Sl. No.	Parameter	Specification
1	Type	Gigabit Ethernet
2	MPEG Format	MPEG 2 TS over IP (SPTS & MPTS)
3	Decoding of Video from TS	i) MPEG-2 ii) H.264/MPEG-4-AVC iii) H.265/HEVC Main 10
4	Decoding of Audio from TS	i) MPEG-1 Layer-II ii) HE AAC V1 & V2 5.1 Audio iii) Dolby Digital AC-3 5.1 Audio iv) Dolby Digital Plus 5.1 E-AC-3 Audio
5	No of Ports dedicated for IP Input source	Minimum two nos. independent ports and configurable in redundant mode
6	Port Speed	1000 Mbps or better per port
7	Ethernet Interface	1000 base T or better
8	Ethernet Connectors	RJ 45

#### F. IP Streaming Input Specifications

Each encoder chassis shall have the facility to pull the channel from Cloud/URL. Thereafter, channel may be decoded; and encoded in desired format for multiplexing with external IP Encapsulator cum Multiplexer. Input format of IP stream is given below:

*am*

*lok*

*→*

*Himanshu*

1. RTMP IP Streaming Input Format of TV Service							
i) HDTV Channel							
Input Format	Streaming Format	Profile Number	Video Decoding standard	Profile	Video Resolution	Audio Decoding Standard	Type of Audio channels
RTMP	MPEG TS i.e. (.TS)	1	H.264	High	1920 x 1080	AAC-LC,V1,V2	Stereo, Mono for AACLC, V1 and V2
		2	H.264	High	1440 x 1080	AAC-LC,V1,V2	Stereo, Mono for AACLC, V1 and V2
		3	H.264	High	1280x720	AAC-LC,V1,V2	Stereo, Mono for AACLC, V1 and V2

ii) SDTV Channel							
Input Format	Streaming Format	Profile Number	Video Decoding standard	Profile	Video Resolution	Audio Decoding Standard	Type of Audio channels
RTMP	MPEG TS i.e. (.TS)	1	H.264	High	720 x 576	AAC-LC,V1,V2,	Stereo, Mono for AACLC, V1 and V2
		2	H.264	High	544 x 576	AAC-LC,V1,V2	Stereo, Mono for AACLC, V1 and V2
		3	H.264	High	480x576	AAC-LC,V1,V2	Stereo, Mono for AACLC, V1 and V2

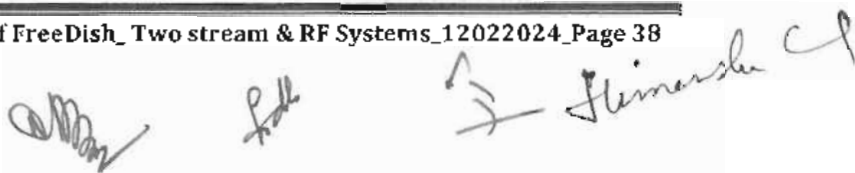

2. HLS IP Streaming Input Format of TV Service							
i) HDTV Channel							
Input format	Streaming Format	Profile Number	Video Decoding standard	Profile	Video Resolution	Audio Decoding Standard	Type of Audio channels
HLS	MPEG TS i.e. (.TS)	1	H.264 & HEVC	High	1920 x 1080	AAC-LC,V1,V2, DD, DD+	Stereo, Mono for AACLC, V1 and V2 5.1 for DD & DD+
		2	H.264 & HEVC	High	1440 x 1080	AAC-LC,V1,V2, DD, DD+	Stereo, Mono for AACLC, V1 and V2 5.1 for DD & DD+
		3	H.264 & HEVC	High	1280x720	AAC-LC,V1,V2, DD, DD+	Stereo for AACLC, V1 and V2 5.1 for DD & DD+
ii) SDTV Channel							
Input Format	Streaming Format	Profile Number	Video Decoding standard	Profile	Video Resolution	Audio Decoding Standard	Type of Audio channels
HLS	MPEG TS i.e. (.TS)	1	H.264 & HEVC	High	720 x 576	AAC-LC,V1,V2, DD, DD+	Stereo, Mono for AACLC, V1 and V2 5.1 for DD & DD+
		2	H.264 & HEVC	High	544 x 576	AAC-LC,V1,V2, DD, DD+	Stereo, Mono for AACLC, V1 and V2 5.1 for DD & DD+



		3	H.264 & HEVC	High	480x576	AAC-LC, V1, V2, DD, DD+	Stereo, Mono for AACLC, V1 and V2 5.1 for DD & DD+
--	--	---	--------------	------	---------	-------------------------	---

**3. SRT IP Streaming Input Format of TV Service**

i) HDTV Channel

Input format	Streaming Format	Profile Number	Video Decoding standard	Profile	Video Resolution	Audio Decoding Standard	Type of Audio channels
SRT	MPEG TS i.e. (.TS)	1	H.264 & HEVC	High	1920 x 1080	MPEG-1 L-II, AAC-LC, V1, V2, DD, DD+	Stereo, Mono for AACLC, V1 and V2 5.1 for DD & DD+
		2	H.264 & HEVC	High	1440 x 1080	MPEG-1 L-II, AAC-LC, V1, V2, DD, DD+	Stereo, Mono for AACLC, V1 and V2 5.1 for DD & DD+
		3	H.264 & HEVC	High	1280x720	MPEG-1 L-II, AAC-LC, V1, V2, DD, DD+	Stereo for AACLC, V1 and V2 5.1 for DD & DD+

ii) SDTV Channel

Input Format	Streaming Format	Profile Number	Video Decoding standard	Profile	Video Resolution	Audio Decoding Standard	Type of Audio channels
SRT	MPEG TS i.e. (.TS)	1	H.264 & HEVC	High	720 x 576	MPEG-1 L-II, AAC-LC, V1, V2, DD, DD+	Stereo, Mono for AACLC, V1 and V2 5.1 for DD & DD+

*Handwritten signatures and initials:*  
 [Signature] [Initials] [Signature]

		2	H.264 & HEVC	High	544 x 576	MPEG-1 L-II, AAC-LC, V1, V2, DD, DD+	Stereo, Mono for AACLC, V1 and V2 5.1 for DD & DD+
		3	H.264 & HEVC	High	480x576	MPEG-1 L-II, AAC-LC, V1, V2, DD, DD+	Stereo, Mono for AACLC, V1 and V2 5.1 for DD & DD+

#### 4. ZIXI IP Streaming Input Format of TV Service

##### i) HDTV Channel

Input format	Streaming Format	Profile Number	Video Decoding standard	Profile	Video Resolution	Audio Decoding Standard	Type of Audio channels
ZIXI	MPEG TS i.e. (.TS)	1	H.264 & HEVC	High	1920 x 1080	MPEG-1 L-II, AAC-LC, V1, V2, DD, DD+	Stereo, Mono for AACLC, V1 and V2 5.1 for DD & DD+
		2	H.264 & HEVC	High	1440 x 1080	MPEG-1 L-II, AAC-LC, V1, V2, DD, DD+	Stereo, Mono for AACLC, V1 and V2 5.1 for DD & DD+
		3	H.264 & HEVC	High	1280x720	MPEG-1 L-II, AAC-LC, V1, V2, DD, DD+	Stereo for AACLC, V1 and V2 5.1 for DD & DD+

*dmz*

*Leh*

*3*

*Shimashu C*

ii) SDTV Channel							
Input Format	Streaming Format	Profile Number	Video Decoding standard	Profile	Video Resolution	Audio Decoding Standard	Type of Audio channels
ZIXI	MPEG TS i.e. (.TS)	1	H.264 & HEVC	High	720 x 576	MPEG-1 L-II, AAC-LC, V1, V2, DD, DD+	Stereo, Mono for AACLC, V1 and V2 5.1 for DD & DD+
		2	H.264 & HEVC	High	544 x 576	MPEG-1 L-II, AAC-LC, V1, V2, DD, DD+	Stereo, Mono for AACLC, V1 and V2 5.1 for DD & DD+
		3	H.264 & HEVC	High	480x576	MPEG-1 L-II, AAC-LC, V1, V2, DD, DD+	Stereo, Mono for AACLC. V1 and V2 5.1 for DD & DD+

#### 5. Input Format of Radio Service received through IP Streaming

Input Format	Profile Number	Streaming Format	Audio Decoding Standard	Type of Audio channels
HLS	1	(i) MPEG TS i.e. (.TS) (ii) Raw audio format(.aac)	(i) AAC-LC, (ii) HE-AAC V1, (iii) HE-AAC-V2,	Stereo , Mono for AACLC, V1 and V2

Each Encoder chassis shall have the facility to encode minimum 8 Radio Service received through IP Input streaming.

*Handwritten signatures and initials:*  
 [Signature] [Initials] [Signature]

**G. Video compression parameters**

Sl. No.	Parameter	Specification
1	Video Resolutions (PAL)	For SDTV 720 x 576, 544 x 576, 480 x 576, For HDTV 1920 x 1080 1440 x 1080
2	Profiles and Levels	i) SD MPEG-2, MP@ML ii) SD H.264/MPEG-4, MP@L3 iii) HD H.264 Main Profile Level 4.0 iv) HD H.264 High Profile Level 4.0 v) HD H.265/HEVC Main 10
3	Video Bit-rate	i) 500 Kbps to 4 Mbit/s for 4:2:0 Profiles of SDTV on MPEG-2 depending upon Resolution ii) 3 to 20 Mbit/s for 4:2:0 Profiles of HDTV in MPEG-4 depending upon Resolution ii) 3 to 8 Mbit/s for 4:2:0 Profiles of HDTV in HEVC depending upon Resolution
4	Temporal Processing	Temporal Processing- I, B, B, P frames structure to support low delay mode with latency delay of 3.5 seconds or less.
5	Coding of Interlaced Video	Adaptive field & frame Processing support
6	Spatial Redundancy	Discrete Cosine Transform (DCT) Reduction
7	Chrominance Format	4:2:0
8	Aspect Ratio	4:3 and 16:9
9	Type of Encoding	Variable bit rate

**H. Audio Compression Parameters**

Sl. No.	Parameter	Specification
1	Audio Encoding Method	i) MPEG-1 layer II ii) HE-AAC (MPEG-4) v1 & v2 5.1 Audio iii) Dolby Digital 5.1 AC-3 audio iv) Dolby Digital Plus 5.1 E-AC-3 audio
2	Data rate	i) 64-192 kbps (MPEG-1, layer II) ii) 32-72 kbps (MPEG-4, HE AAC V1 encoding) iii) 16-48 kbps (MPEG-4, HE AAC V2 encoding) iii) 224-640 kbit/s (Dolby Digital 5.1 audio encoding) iv) 192-640 kbit/s (Dolby Digital Plus 5.1 audio encoding)

**I. IP Transport Stream Output Specification**

Sl. No.	Parameter	Specification
1	Type	Gigabit Ethernet
2	MPEG Format	MPEG 2 TS over IP
3	No of Ports dedicated for IP Output	Minimum two nos. independent ports and configurable in redundant mode
4	Speed	1000 Mbps or better per port
5	Addressing	Unicast and Multi cast (at a time only one).
6	Ethernet Interface	1000 base T or better
7	Ethernet Connectors	RJ 45

**J. Control and configuration of Encoder chassis**

Sl. No.	Parameter	Specification
1	Control port	Min. 1 no. 10/100/1000 Base-T Ethernet port for NMS
2	Connector Type	RJ 45

**K. Hardware of Server in case of software compression solution****a) General Feature:**

- i. CPU/Chipset of server should have facility to enable an environment where applications can run within their own space, protected from all other software on the system.
- ii. CPU/Chipset of server should have security feature that can reduce exposure to viruses and malicious-code attacks and prevent harmful software from executing and propagating on the server or network.
- iii. CPU/Chipset of server should have facility of Secure Key consisting of a digital random number generator that creates truly random numbers to strengthen encryption algorithms.
- iv. CPU/Chipset of server should have Thermal Monitoring facility to protect the processor package and the system from thermal failure.
- v. The offered processor of server should be scalable, high quality, robust with efficient performance.
- vi. Each server of software compression solution should be designed with 85 percent (Max.) CPU loading.
- vii. CPU of server shall be similar to Intel Xeon Gold series or better and launch date of CPU of server should not be prior to year 2020.

- viii. Facility to store the last configuration in the network hardware so that in case of failure of the Compression System Control Computer, the system remains running and continues to Statistically multiplex two or more programme as per the last good configuration.

**b) Hardware Feature:**

Sl. No.	Parameter	Specification
<b>A</b>	<b>Performance of Central Processing Unit</b>	
1	No. of Core	18 (Min.) per CPU
2	No. of Thread	36 ( Min.) per CPU
3	Processor Basic Frequency	2.10 GHz or better
4	No. of CPU	Two or more
<b>B</b>	<b>Memory Specification</b>	
5	RAM	DDR4, 64 GB or more
6	Storage Memory	SSD, 240 GB (Min.) in Raid 1 Configuration
<b>C</b>	<b>Operating System</b>	
7	Operating system	Linux
<b>D</b>	<b>Ethernet Network</b>	
8	No. of Ports (Duplex) in server	i) Two nos. of 1 Gigabit port for Input or more ii) Two nos. of 1 Gigabit port for Output or more iii) Two nos. of 1 Gigabit port for Management & Control iv) Two nos. of 1 Gigabit port for Ancillary services
<b>E</b>	<b>PCI slot</b>	
9	PCI slot	2 nos. or more
<b>F</b>	<b>Operating Environment</b>	
10	Operating Temperature	10 to +35 °C
11	Humidity	10% to 90% non-condensing

**5.2.3 Specification for IP Data Switch**

**A. Features**

- (i) Multicast IP routing, and access control list of connected hardware.
- (ii) Redundant swappable Power System for protection against power supply failures.
- (iii) IEEE 802.1/w Rapid reconfiguration of Spanning Tree, and IEEE802.1s Multiple VLAN instances of spanning Tree.

- (iv) IEEE 802.1x support for dynamic, port-based security, providing user authentication, MACSEC security.
- (v) Real-time network fault analysis with easy-to-deploy device specific best-practice templates.
- (vi) The required hardware and software including their licenses shall be provided for Multicast IP Routing, VLAN configuration and GUI of the switch for configuration and Monitoring of IP ports through Compression NMS.
- (vii) The required Hardware & associated accessories (Cable with Connector) and software including their licenses shall be provided for stacking of the all IP Switches.

### B. Specification

Sl. No.	Parameter	Specification
<b>A Performance</b>		
1	Forwarding rate	72 Mpps (100 MBps) or better
2	Memory:	
i	DRAM	4 GB (Min)
ii	FLASH	2 GB (Min)
3	Ethernet ports 10/100/1000 (Selectable)	a) 48 (Min) for 48 Port IP Data Switch b) 24 (Min) for 24 Port IP Data Switch
4	Switching capacity	176 Gbps(Min)
5	Throughput	72 Mpps (Million packets per second) or better
6	IPv6 support	in software
7	Uplink optics type	4 SFP (Min 10 GB per SFP port) with single-mode SFP modules (optical device/cartridge).
8	CPU	800 MHz (Min)
9	Shared buffer	12 MB (Min)
10	Height of IP Switch	1 RU
<b>B Indicators</b>		
11	Per-port status LEDs	link integrity, disabled, activity, speed, and full-duplex indications
12	System-status LEDs:	Fan, power and system Indicator

*Handwritten signatures and initials:*  
 [Signature] [Initials] [Signature]

#### 5.2.4 IP Encapsulator cum Multiplexer Specifications

##### A. Features:

- i) Each IP Encapsulator cum multiplexer shall be capable of multiplexing minimum of 64 SDTV services or 20 HDTV services or combination of both SD & HD service + 8 Radio channels (only in CBR) with DVB-CSA (V-1 & V-2) supported DVB-CAS simulcrypt encryption through IP and ASI in CBR and/or VBR mode inputs per transport stream. It should have the facility for statistical Multiplexing, scrambling, De-multiplexing and again multiplexing the relevant/required services.
- ii) The Compression system ( Either IP Encapsulator cum multiplexer or Encoder) should be able to create independent as well as combination of pool of services mux in statistical & CBR for MPEG 2, H.264/MPEG 4 and H.265/HEVC Compressed streams of SD & HDTV channels.
- iii) Each IP Encapsulator shall have enabled minimum four independent IP data port (Bi-directional), one IP port for DVB-CSA (V-1 & V-2) supported DVB-CAS with simulcrypt encryption & four independent ASI input port and four independent ASI output port, so that IP Encapsualtor shall be able to take input stream/signal through IP as well as ASI port for multiplexing the channels and take out multiplexed transport stream through IP on RJ 45 as well as ASI on BNC/HD BNC/Micro BNC port.
- iv) Each IP Encapsulator shall generate four independent ASI output transport stream with DVB-CSA (V-1 & V2) supported DVB-CAS simulcrypt Encryption(CAS) for transmission with option of generating ASI output transport stream without DVB-CAS encrypted (free to air) for monitoring of this set up.
- v) Each IP Encapsulator should be capable to multiplex both SDTV and HDTV signal simultaneously with DVB-CSA (V-1 & V-2) supported DVB-CAS simulcrypt encrypted ASI output as well as without DVB-CAS encrypted (free to air) independent ASI transport output for monitoring.
- vi) It should be possible to include any HD encoder part of any mux pool and transport stream irrespective of its physical location at IP switch and Route any service through any Input to any output.
- vii) There should be a facility to add minimum four numbers of configurable ASI port for implementation of DVB-CSA (V-1 & V2) compliant CAS system without any up-gradation by way of hardware and software in future.
- viii) IP Encapsulator should be capable to accept variable video bit rate Programme Stream and Multiplex the multiple streams in a multiple

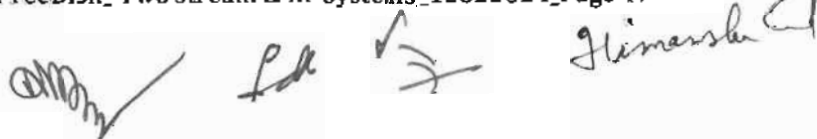
 The bottom of the page contains several handwritten signatures and initials. From left to right, there is a signature that appears to be 'M. M.', followed by the initials 'Lok', a checkmark, and a signature that appears to be 'Gimansh'.



Multiplexing Group i.e. "n x services" and allocate optimum bit rate to the services in the Transport Stream.

- ix) The multiplexer shall be capable of transmission of broadcast data signals along with video and audio.
- x) IP Encapsulator should have DVB compliant for encapsulation of EPG data, DVB-SI/PSI table, NIT table, EMM table, ECM table generated by EPG and DVB-SI/PSI Generator/Server and CAS server in the output of transport streams.
- xi) Each IP Encapsulator cum Multiplexer unit should have Hot swappable dual redundant SMPS Power Supply.

### B. Technical Specification

Sl. No.	Parameter	Specification
a)	<b>IP data Port Specifications</b>	
1	Type	Gigabit Ethernet 802.3z
2	No. of Ports for input and output data	i) Minimum four nos. physical independent 1 Gigabit RJ45 ports (Bi-directional) with licenses (2 ports for Input & 2 ports for output configurable). ii) Minimum four nos. physical independent 10 Gigabits SFP port (Bi-directional) with SFP optical device cartridge.
3	I/O Speed	Min 900 Mbps per port
4	IP Encapsulation	MPEG -2 TS over IP
5	MPEG Format	188 B per TS
6	Addressing	Unicast and Multi cast (at a time only one).
7	Ethernet Interface	1000 base T
8	No. of Ports for ancillary data	Min. 2 Nos. physical 1 Gigabit RJ 45 port (Bi-directional)
9	Ethernet Control and Management connector	Min. 1 no RJ 45 for control and management
b)	<b>DVB-ASI Transport Stream Input Specifications</b>	
1	Format	MPEG-2 TS/ DVB-ASI
2	Quantity	Minimum 4 independent ports
3	Connector	BNC/HD BNC/Micro BNC; Female

*[Handwritten signature]*

*[Handwritten signature]*

*[Handwritten signature]*

*[Handwritten signature]*

c)	<b>DVB-ASI Transport Stream Output Specifications</b>	
1	Format	MPEG-2 TS/ DVB-ASI
2	Quantity (No. of o/p Port)	Minimum Four Independent ports configurable to DVB-CSA (V-1 & V-2) encryption for transmission. These ports shall also be enabled to simulcrypt minimum two DVB-CAS encryption and configurable to free to air mode for monitoring.
3	Transport Stream output	100 Mbps per Output Stream
4	Connector	BNC/HD BNC/Micro BNC; Female
d)	<b>DVB-CSA ( V-1 &amp; V2) supported simulcrypt DVB-CAS Feature</b>	
1	IP Port for DVB-CSA V-1 & V-2 supported DVB-CAS Control with required licenses	Minimum one port (RJ-45)
2	No. of DVB-CAS to be simulcrypt	Minimum two CAS
3	Name of CAS to be deployed	Generic Conditional Access System (CAS)
4	IP data port for OTA with required license	Through IP data port or ASI input port
5	Scrambling Feature with required licenses	On all independent output port with each service and ON-Off facility.
6	EMM processing bandwidth	4 Mbps or better
7	ECM processing bandwidth	15 kbps or better per channel

### C. Statistical Multiplexing:

- (i) There should be Statistical Multiplexing software to enable Doordarshan to control the configurations of each channel encoder in order to optimize the bit rate used to encode the video material.
- (ii) The statistical Multiplexing shall essentially have following feature:-
- User selectable minimum & maximum bit rates per channel.
  - Provision for linear bit rate changeover on frame by frame basis as per specified bit rate of each channel.
  - There shall be no break in service during change of bit rate of compression equipment and also during transition to redundant IP Encapsulator cum Multiplexer. There shall be no requirement of rebooting of the compression equipment for effecting the change in configuration.

Handwritten signatures and initials are present at the bottom of the page, including a signature that appears to read "Steinash" and other illegible marks.

- d. Real time bit rate management for continuous allocation of bandwidth between the encoders using only native hardware and software of encoders and multiplexer i.e. without the use of any additional / external computer hardware or software.
- e. Stat Mux facility should support among all SDTV & HDTV channel with DVB-CSA (V-1 & V-2) supported simulcrypt DVB-CAS encryption (CAS).
- f. Fast response to the variations as per the complicity of the source material.
- g. Enabling of statistical Multiplexing shall not need any change in the hardware or software of the receiving equipment i.e. STBs.

**D. Implementation of DVB-CSA (V-1 & V-2) supported DVB-CAS, EPG, Video on Demand (VoD), NVoD, Subtitling, Audio descriptor, closed captioning etc.**

Services like DVB-CSA (V1 & V-2) supported with simulcrypt DVB-CAS encryption (CAS), Subtitling, Audio descriptor, EPG etc will be carried by the DD free Dish DTH platform and the equipment offered by the bidder shall be capable of carrying these services without any limitation or requiring upgradation by way of hardware and software. *The offered IP Encapsulator cum multiplexer shall also be Video on Demand (VoD) & NVoD with .TS format compliant, however Storage server, Play out system, GSM or IP based network for return path are not in the scope of this tender.*

**5.2.5 Specification for 16x16 or better matrix SDI/ASI Routing Switcher**

**A. General:**

The equipment should be very reliable and able to be used for selection of any one of the ASI/ SDI input signals to all destinations. The equipment so offered should be for professional Broadcast applications. The Router has to be quoted with X-Y and Single Bus control panels.

**B. Essential Features:**

- i. The routing switcher electronics should be capable of being mounted in a standard 19" rack frame.
- ii. The switcher shall handle SDI/ ASI signal for routing from input to output destinations. The switching should take place during the vertical interval period with re-clocking.

- iii. The switcher should have storage facilities for control information, so that in case of power supply failure, the status of the switcher output should remain unchanged when the power supply is restored.
- iv. The switcher should have a built in Auto-Switchable redundant dual power supply.
- v. The switcher quoted against this specification should be complete in all respects and should have the desired features.
- vi. A certificate from Compression OEM regarding compatibility with compression is required to be submitted alongwith the bid.
- vii. Any of the input shall be capable of being switched to any or all outputs of router.
- viii. Number of input and output port of ASI/SDI Router shall be same.

#### C. Technical Specification:

Sl. No.	Parameter	Specification
1.	Matrix size	16x16 or better matrix
2.	Input	SDI/ASI ( BNC 75 ohms)
3.	Equalization	Automatic: 150 Meters at 270 Mbps.
4.	Output	SDI/ASI (BNC 75 ohm)
5.	Return Loss	Should be maintained better than 15 dB on data rate up to 270 Mb/s throughout the switching chain.

### 5.2.6 Compression System Control Computer with Software

#### A. Compression System Management Functions

- (a) The compression system control computer shall control the operation, redundancy switching and configuration of all parameters of encoders, IP Encapsulator cum multiplexers, SDI & ASI routers and IRDs including alarm and fault logs for a minimum of 365 days or configurable to 90/120/180 days subject to limitation of hard disk space.
- (b) The NMS(Compression control system) offered should be capable to mux 60 TV channels (min) per mux group. However, there should not be any restriction on total number of streams.
- (c) NMS shall have the facility to configure, control and monitor minimum 75 equipment/elements like IRDs, Encoders, IP Encapsulator cum Multiplexers, SDI Router, ASI Router, RCPs, IP Switches etc.

**B. Salient Features:**

The System Control Computer shall be used as a control protocol to configure the various parameters for the statistical multiplexing such as:

- i. To configure encoders for variable Bit Rate Transport Stream. Setting of minimum and maximum limits of data rate for each encoder.
- ii. To configure GOP pattern for frame-by-frame encoding. Encoding should take place at the encoder in real time.
- iii. If the System Control Computer fails or powered down, the whole system should be failure protected so that it still works.
- iv. Facility to store the last statistical Multiplex configuration in the network hardware so that in case of failure of the Compression System Control Computer, the system remains running and continues to statistically multiplex two or more program as per the last good configuration.
- v. To configure IRDs supplied by OEM to any pre-defined TV channels.
- vi. There shall also be a facility to configure the encoders for pre-defined Image(PNG/JPEG, GIF format) on the loss of video input in NMS.
- vii. There shall be facility to create ghost backup of hard disk of NMS computer on USB storage.
- viii. Each set of Network Management System (NMS) shall comprise of (1+1) rack mounted server for 24x7 operation in master and slave configuration or cluster configuration with four client licenses.
- ix. There shall be four client PCs with required licenses and 21 inch or better size display monitors along with each PC for monitoring of all offered NMS system from remote locations.
- x. These client PCs shall be installed in old compression room, Monitoring room, shift in-charge room and supervisor room. The supervisor room is located 100 meters away. An Ethernet connection required to be provided on the client PC for monitoring in supervisor room.
- xi. The Compression Control Computer (NMS) should be capable of controlling and monitoring all parameters of the digital video and audio compression system through suitable hardware interface and user friendly GUI.
- xii. To facilitate centralized network management operations in future, it should be possible to operate the system remotely via a suitably configured computer and dial-up telephone lines/Broadband network. It should be supplied with complete hardware and software to interface all the equipment in the chain for their proper control and monitoring.

*[Handwritten signatures and initials]*

- xiii. The complete compression NMS software of each set is to be loaded on a single control computer/Server with networking facilities if offered in Master and slab mode, whereas compression NMS software of each set is to be loaded on two control computer/Server with networking facilities in cluster mode.

### C. Required Hardware and Software

The compression system control computer shall be based on industry standard, open system hardware and software that will provide a user-friendly GUI to the operator.

Sl. No.	Parameter	Specification
1	Man Machine Interface	Graphical User Interface (GUI)
2	Operational Features	Based on latest Windows / Linux version: (a) Diagnostic log (b) Transaction log (c) Password privilege system (d) Dial in modem support/through Broadband (e) Multi user terminal support
3	Physical Connection to Equipment	Ethernet 10 Base-T/100 Base-T through CAT 6 or better cable
4	Hardware Platform	Supplier to provide full details of the industry standard hardware platform proposed
5	Software	Supplier to provide full details of the industry standard software platform proposed
6	Back up on USB storage	The back up/ recovery USB storage for all the software are to be provided with proper licenses.
7	No of Equipment/Element to be controlled by offered Compression NMS	75 nos. (Minimum)
8	Storage Memory	SSD, 240 GB (Min.) in RAID 1 Configuration

### D. Remote Access

It shall be possible to add a remote user terminal and modem/IP interface to provide access to the control system computer from a remote location via dial up telephone line/ Broadband network. The remote user shall have access to all the commands available at the main control system, subject to password restrictions for security. The remote user shall be presented with a user interface, which is identical to the local user interface.

*Handwritten signatures and initials:*  
 ammy, Lee, J, Himanshu

### 5.2.7 3G/HD/SD SDI and MPEG-2 TS DVB/ASI Distribution Amplifier system

#### A. Technical Features :

1. 3G/HD/SD SDI and DVB/ASI Compliant 1 x N (where N is the number of relocked outputs and is equal to 2 or more) Distribution Amplifier system shall support a variety of compressed and uncompressed serial digital video signals.
2. The Distribution Amplifier (DA) system shall restore the incoming MPEG-2 TS DVB/ASI signal to its proper amplitude. The signal is reshaped with automatic equalization, DC restoration, and re-clocking.
3. The unit should automatically detects the data rate for incoming channels and then re-clocks and equalizes the signal.
4. The Distribution Amplifier system should be rack mountable, having dual redundant power supply and should have LED indicators at the front of the module to identify the presence of incoming video, and the data rate etc. External power supply adopter is not acceptable.
5. There should not have more than two Distribution Amplifier cards housed in one Chassis. or only two channels per chassis.

#### B. Technical specification-

Sl. No.	Parameter	Specification
1	Input	3G/HD/SD SDI and DVB/ASI compliant .
2	Input Connectors:	75Ω BNC
3	Input/Output Standards	SMPTE 259M, 292M, 372M, and MPEG-2 TS DVB/ASI Compliant
4	Input/Output Bit Rates	Up to to 2.97Gbit/s
5	Input Return Loss	≥15dB up to 1.5 GHz/1485Mbps ≥10 dB from 1.5 GHz to 3 GHz
6	Input/Output Signal Level	800mV
7	Input Cable Length (min) (Belden 1694A cable)	SD/ASI Equalization: 500 feet @ 270Mbps HD Equalization: 250 feet @ 1485Mbps 3G Equalization 100 feet @ 2900Mbps
7	Number of Outputs	2 (Min) 75Ω BNC
8	Output Return Loss	≥15dB up to 1.5 GHz/1485Mbps ≥10 dB from 1.5 GHz to 3 GHz
9	Overshoot	< 10% of Amplitude
10	Power supply	200 - 264 VAC, 47 – 63 Hz (External adopter is not accepted)
11	MECHANICAL	Rack Mount Enclosure (1RU)

### 5.2.8 Optical Fiber Communication link (OFC) system

#### A. Essential Features -

1. OFC system is an OFC link for receiving MPEG-2 TS over IP of each four Compression chains (two existing and two offered) (i.e. from IP Data Switch of each chain) in old compression room to Digital Satellite Modulators to be installed in Porta Cabin in 4x (1+1) configuration, consisting of Single Channel Optical Transmitter & Receiver Units (including Fiber Management system), through suitable OFC and IP Data cables, and Chassis for the above with control card for configuration & monitoring and dual redundant power supply units.
2. OFC system is an OFC link for receiving MPEG-2 TS over IP of each four existing Compression chains (i.e. from IP Data Switch of each chain) in new compression room to Digital Satellite Modulators to be installed in Porta Cabin in 4x(1+1) configuration, consisting of Single Channel Optical Transmitter & Receiver Units (including Fiber Management system), through suitable OFC and IP Data cables, and Chassis for the above with control card for configuration & monitoring and dual redundant power supply units.
3. The offered Optical Fiber Communication link (OFC) system shall also include suitable Optical Fiber Cable, Optic Patch cords, SFP optical device cartridge, and other required standard accessories.
4. The offered solution should be scalable and modular in design and architecture. The offered system should have space for future expansion by adding additional minimum one optical transmitter and/or receiver modules.
5. The system should have built-in 1:1 dual redundant & hot-swappable power supply units.
6. Trans & Receive unit shall be configurable locally or remotely via Web-Interface (Web-GUI, SNMP etc).
7. The optical cards should support single mode optical transport for better link margin.
8. It should have comprehensive LED indicators on Transmitter and Receiver module and/or LCD/LED/OLED Display panel on chassis for status information.

*am* *Lele* *✓* *Jimarsah*



9. All the requisite drivers, software and licenses required for meeting the DD specifications must necessarily be pre-loaded and configured by the OEM before supplying equipment to DD

**B. Single Channel Optical Transmitter:-**

- a. Optical Fiber Communication link (OFC) system consist of Gigabit Ethernet Fiber Transmitter which receive MPEG-2 TS over IP /DVB ASI over IP and transmits DVB ASI over IP signals over Optical Fiber Output.
- b. It should supports transmission of DVB-ASI over IP.
- c. It should be compatible with single-mode fiber.
- d. It should have input signal presence and transmitter module status monitoring/indication on LED/OLED/LCD display.
- e. It should have minimum one outputs for loop-through or for monitoring.

I	INPUT	
1)	Input type	MPEG-2 TS over IP /DVB ASI over IP
2)	Connector	Minimum one No (RJ45)
3)	Bit Rate	Better than 900 Mbps
4)	Port Speed	Better than 900 Mbps
II	OUTPUT	
1)	Output type	DVB ASI over IP signals over Optical Fiber Output
2)	Connector	SC/PC connector along with SFP cartridge for DVB ASI over IP signals over Optical Fiber Output
3)	Wave length	1310nm, 1550nm (nominal)
	Output Power	-7dBm $\pm$ 1dBm
4)	No. of outputs	One (min)
5)	Mode	Single
6)	Standard	DVB ASI over IP signals over Optical Fiber

*Handwritten signature*

*Handwritten signature*

*Handwritten signature*

*Handwritten signature: Himanshu*

**C. Single Channel Optical Receiver:-**

- a. Optical Fiber Communication link (OFC) system consist of Gigabit Ethernet Fiber Receiver which receive DVB ASI over IP signals over Optical Fiber and give output as MPEG-2 TS over IP/DVB ASI over IP signals.
- b. It should be compatible with single-mode fiber.
- c. It should have input signal presence and receiver module status monitoring/indication on LED/OLED/LCD display.
- d. It should have minimum one outputs for loop-through or for monitoring.

I		INPUT
1)	Input type	DVB ASI over IP signals over Optical Fiber Input
2)	Connector	SC/PC connector along with SFP cartridge for DVB ASI over IP signals over Optical Fiber Output
3)	Wave length	1310nm, 1550nm (nominal)
	Input Power	-1dBm
5)	Mode	Single
II		OUT PUT
1)	Output type	MPEG-2 TS over IP /DVB ASI over IP
2)	Connector	Minimum one No (RJ45)
3)	Bit Rate	Better than 900 Mbps
4)	Port Speed	Better than 900 Mbps

**5.3 Specification for Satellite Modulator System**

The Satellite Modulator System consists of the following equipment.

- a) Satellite Modulator in (1+1) redundant configuration
- b) IF Redundancy switch.

**5.3.1 Specifications for Satellite Modulator****a) Essential Features:**

- i) The offered modulator should be compact, reliable and have state of the art technology.

- ii) It should provide IF output ( $70 \pm 18$  MHz ) as per DVB-S and DVB-S2 standards' modulation schemes based on the user requirement.
- iii) It should have facility to auto equalization or pre-equalization to pre-distort signal before feeding to Up-converter based on received signal from existing LNA, so that downlink signal is kept within 36 MHz BW of the transponder. This should not affect the operation of the existing IRDs (MPEG-2, MPEG-4, HEVC and DVB-S & DVB-S2 compliant).
- iv) The offered modulators should have front panel display. It should be possible to configure the offered modulators through front panel keys and through browser on remote computer.
- v) The offered modulators should be compliant to the ETSI 103 129 DVB Carrier ID (DVB-CID) requirement.
- vi) The offered modulators will be used in 1+1 redundant mode.
- vii) The redundancy of the offered modulators shall be controlled through the offered IF redundancy switch.
- viii) In case of failure of main/ redundant modulator, audio/visual alarm should be generated to indicate the failure of main/ redundant modulator.
- ix) The offered Modulators should have facility to take ASI input through BNC port and MPEG2 TS over IP input through IP data port .
- x) All the requisite drivers, software and licenses required for meeting the DD specifications must necessarily be pre-loaded and configured by the OEM before supplying equipment to DD.

**b) Technical Specifications:**

Sl. No.	Parameter	Specifications
<b>I. ASI Inputs</b>		
1	Compliance	DVB Document A010 rev. 1, May 1997: Section 4.4
2	Byte stuffing modes	Byte and single packet burst mode.
3	Connector	BNC
<b>II. IP Data Port{External IP to ASI converter is not acceptable.}</b>		
1	Input data format	MPEG-2 TS over IP
2	Ethernet interface	1000 base T
3	Ethernet Connector	1xRJ45

<b>III. Forward Error Correction and Modulation Scheme as per DVB-S standard</b>		
1	Multiplex Adaptation and Energy Dispersal	As per ETSI EN 300 421 (DVB-S)
2	Outer Coding	Reed-Solomon (204,188,T=8)
3	Interleaving Depth	12
4	Inner coding	QPSK: Convolution R=1/2, 2/3, 3/4, 5/6 or 7/8
5	Spectrum Roll off factor	20%, 25 % and 35% selectable
6	Modulation	QPSK
7	Transmission rates	Variable, 1.0 to 45.0 M symbol/s (min.)
<b>IV. Forward Error Correction and Modulation Scheme as per DVB-S2 standard</b>		
1	Multiplex Adaptation and Energy Dispersal	As per EN 302 307 (DVB-S2)
2	Modulation	QPSK, 8PSK
3	Modulation mode	Should be capable of emitting signals on the following modes: 1. Backward compatible mode (DVB-S/ DVB-S2 one at a time) 2. Constant Coding and Modulation mode (CCM)
4	Outer Coding	BCH
5	Inner coding	LDPC R= 1/2, 3/5, 2/3, 3/4, 4/5, 5/6, 8/9, 9/10 (for DVB-S2, QPSK), R= 3/5, 2/3, 3/4, 5/6, 8/9, 9/10 (for DVB-S2, 8PSK)
6	Spectrum Roll off factor	5%, 10%, 15%, 20%, 25% and 35% selectable
7	Transmission rates	Variable, 1.0 to 45 M symbol/sec (min.)
<b>V. IF output Interface Specifications</b>		
1	Output Frequency Range	70 ± 18 MHz
2	Output Impedance	75 ohms unbalanced
3	Connector	BNC, female
4	Output Return Loss	15 dB (min.)

5	Output Level Range	-20 dBm to 0 dBm
6	Level Step Size	0.2 dB max.
7	Spurious Outputs	$\leq -55$ dBc/4 kHz at 0 dBm output power level in Band. or $< -60$ dBm out side Band
8	Synthesizer Phase Noise	Should meet the requirements of IESS-308
9	CW mode	Selectable
10	Noise floor (No / C)	$< -120$ dBc/Hz
<b>VI. Internal 10 MHz clock &amp; Synchronization</b>		
1	Frequency stability with respect to temperature	$< \pm 2.5$ ppm over $0^\circ$ to $50^\circ$

### 5.3.2 Specifications for IF Redundancy switch

#### a) Essential Features:

- i) The offered IF redundancy switch must be from the OEM of offered satellite modulator to ensure compatibility of the offered IF redundancy switch with the offered modulator system.
- ii) In case of failure of main/ redundant chain, audio/visual alarm should be generated to indicate the failure of main/ redundant chain.
- iii) The offered IF redundancy switch should have dual redundant power supplies.
- iv) Facility for automatic, Manual and remote (through web interface) switching of the satellite modulator should be available through the IF Switch.
- v) The switch should have high reliability, robustness and should be of professional type.
- vi) All the requisite drivers, software and licenses required for meeting the DD specifications must necessarily be pre-loaded and configured by the OEM before supplying equipment to DD.

#### b) Technical Specifications

Sl. No.	Parameter	Specifications
i)	Operating frequency range	50 to 200 MHz
ii)	Insertion loss	$\leq 3$ dB

*(Handwritten signatures and initials)*

iii)	Isolation	
	a) Input to input	45dB min
	b) input to output	50dB min
iv)	Input return loss	13 dB min
v)	Output return loss	13 dB min
vi)	IF connector	BNC/SMA type
vii)	Impedance	75 Ohms
viii)	Remote control	RS232or RS422/485 or RJ 45

#### 5.4 Specification for RF system

The RF Chain consists of the following equipment.

- Ku-Band Up-converter(U/C) in (1+1) redundant configuration.
- KHPA (Ku-Band, 2.45 k W) in (1+1) redundant configuration.
- RF equipment control system.

##### 5.4.1 Specification for Ku Band Up - Converters

S. No.	Parameter	Specification
1	Input Frequency	70 ±18 MHz
2	Output Bandwidth	±18 MHz
3	Frequency Step Size	Synthesized 125 KHz or better
4	Input Power	-20 dBm to 0 dBm
5	Output Frequency Range	13.75 GHz to 14.50 GHz
6	Frequency Stability	± 1 x 10 <sup>-8</sup> ppm from 0°C to 50°C
7	Output power at P1 dB	10dBm
8	Phase noise	IESS 308/309 compliant or better
9	Spurious	-60 dBc at 0 dBm output carrier related or better -65 dBm non carrier related or better
10	Third order intermodulation at 0 dBm	-45 dBc or better
11	Input return loss	18 dB minimum
12	Input Impedance	75 Ohms
13	Output Impedance	50 Ohms
14	Output return loss	18 dB
15	Gain	30 dB or better
16	Amplitude response/ Gain Flatness	± 1.0 dB per 36 MHz (Max)
17	Gain Adjustment step size	0.2 dB (Max)
18	Remote Control	RS422/485 or RJ 45 or any other port. This should be connectable to LAN using required format converters.

*Handwritten signatures and initials:*  
 DMH ✓      Loh      ✓      J. J. J.      J. J. J.

#### 5.4.2 Technical Specifications for RF Redundancy Switch:

##### A. Essential Features:

- (i) The external RF redundancy switch only shall be offered.
- (ii) The offered Up-converter and RF Redundancy Switch should be of same make so that both are compatible for providing the redundancy.
- (iii) In case of failure of main Up-converter, the RF Redundancy switch should be able to provide RF signal output from redundant Up-converter.
- (iv) Facility for Automatic, Manual and Remote switching should be available.
- (v) In case of failure of main/redundant Up-converter, alarm should be generated to indicate the failure of main/redundant Up-converter.

##### B. Technical Specifications:

Sr. No.	Parameters	Specifications
(i)	Operating Frequency Range	13.75 GHz to 14.50 GHz
(ii)	Insertion loss	≤ 0.5 dB
(iii)	Isolation	60 dB or better
(iv)	Input return loss	13 dB min
(v)	Output return loss	13 dB min
(vi)	RF Input/Output Connector	SMA/N-Type
(vii)	Impedance	50 Ohm
(viii)	Remote control	RS232 or RS422/485 or RJ 45 or any other port. This should be connectable to LAN using required format converters.

#### 5.4.3 Specification for Klystron High Power Amplifier (KHPA )

##### A. Introduction

- (i) The Klystron High Power Amplifier (KHPA) is to be used for the final power amplification of the digital RF signal in Ku- band, to be fed to the antenna after proper processing through filters, diplexer, switching networking etc.
- (ii) The KHPA is to be supplied with linearizer (as an integral part).
- (iii) The KHPA will be used in (1+1) redundant configuration.
- (iv) Bidder should quote for the state of the art, highly efficient Klystron.

*[Handwritten signature]*

*[Handwritten signature]*

- (v) The KHPA should be supplied with power saver for lower power consumption when KHPA is operational in low RF power output.
- (vi) Bidder should also supply and install aluminum duct or HDPE pipe as per site requirement to take out hot air of each KHPA from KHPA room to outside the room.
- (vii) It should have provision for monitoring the forward RF power, reflected RF power, Beam Voltage and current, Heater Voltage, KHPA temperature etc. on the front panel display as well as on the remote computer through browser.
- (viii) The OEM should give a detailed account of the protection systems for abnormal rise in temperature, reflected power, voltage, current etc, available in the amplifier and its functioning. All the monitoring and protection system should support the latest digital control.
- (ix) OEM should give the average life of the tube and precautions to be taken to get the quoted life.

#### B. Technical Specification

S.No.	Parameter	Specification
1	Type of amplifier	Klystron HPA
2	Frequency range	13.75 GHz to 14.50 GHz
3	Klystron output power	2.45 kW
4	Output power at flange	2.00 kW (min.) for all channels.
5	RF bandwidth(-1 dB)	85 MHz (min.)
6	RF output power adjustment	0 to - 20 dB continuous
7	Gain (at rated output)	77 dB min.
8	Gain stability	± 0.25 dB per 24 hrs. (max.) at constant drive and temperature 1 dB max. from 20° to 40°C, ± 2.5dB max. from 0° to 50°C (at constant drive)
9	Gain Slope	0.04 dB/MHz max over $F_0 \pm 30$ MHz
10	Input VSWR	1.25 : 1 max
11	Output VSWR	1.30 : 1 max
12	Load VSWR	2.0 : 1 max for full spec. compliance; any value for operation without damage.
13	AM/PM conversion	4 Degree/dB at the rated output
14	Harmonic Output with filter	-80 dBc

Handwritten signatures and initials are present at the bottom of the page, including "Sankar" and "Srinivasan".



15	Noise and Spurious	<-135 dBW/4 KHz, 11.70 to 12.75 GHz; < -65 dBW/4 KHz, pass band; < -60 dBW / 4KHz, pass band with linearizer; <-110 dBW/ MHz, 12.75 to 40 GHz, excluding passband
16	Phase Noise	IESS 308/309 compliant or better
17	Inter modulation Products	-28 dBc with regard to each of two equal carriers at 7 dB backoff from rated output power
18	Group delay (in any 72 MHz band)	0.1 ns/MHz (linear) max 0.02 ns/MHz <sup>2</sup> (Parabolic) max 2.0 ns pk-pk ripple max.
19	Preset channels	Up to 24
20	Primary Power	380 V - 415VAC, 3 phase, 5 wire with ground; 208VAC (with or without neutral) ( $\pm 10\%$ ), 50 Hz $\pm 2\%$
21	Power consumption	8.0 kW max. Supplier should quote the exact figure at various back offs with the power saver unit "OFF" and with Power saver "ON".
22	Power factor	0.90 (min)
23	Inrush Current	180 % of normal line current peak, max (first half cycle only)
24	Operating temp	-10° C to + 50° C
25	Relative humidity	95% non condensing
26	Altitude	1000 m with standard adiabatic de-rating of 2°C/1000 ft. operating, 40,000 ft. non-operating
27	Acoustic noise	63 dBA at a distance of 3 feet from the front panel
28	Cooling	Forced air with integral blower and power supply fan
29	RF Input connector	N type female
30	RF Output connector	WR 75 flange, grooved
31	RF power monitor connectors	N Type female

32	Dimensions	Supplier should give the dimensions of the system including RF section and power supply section
33	Remote monitoring control	Supplier has to integrate the KHPAs with the remote control and monitoring facility, which can be monitored as well as operate the system from a distance via RS 232/422 or 485, Ethernet.

#### 5.4.4 RF Equipment Control System:-

##### A. RF control System Management Functions

The RF system control computer shall control the operation, redundancy switching and configuration of the all parameters of HPA, UP-converter, Satellite Modulator including alarm, audio visual warning and fault logs for a minimum of last 365 days.

##### B. Required Hardware and Software

- (i) The RF system control computer shall be based on industry standard hardware and software that will provide a user-friendly GUI to the operator.
- (ii) It shall consist of Rack mounted (1+1) Server with at least 17 inch or bigger foldable display, keyboard & Mouse with Rack mounting Kit etc to be installed in Porta Cabin i.e. HPA Room.
- (iii) It shall also consist of one client computer (along with client license) with 21 inch display monitor, keyboard, mouse (Rack mounted computer in monitoring room).

S. No.	Parameter	Specification
1	Man Machine Interface	Graphical User Interface (GUI)
2	Operational Features	Based on latest Windows version (a) Diagnostic log (b) Transaction log (c) Password privilege system (d) Multi user terminal support
3	Physical Connection to Equipment	Ethernet 10/100 Base-T/CAT 6 or better
4	Hardware Platform	Supplier to provide full details of the industry standard hardware platform proposed

*[Handwritten signatures and initials]*

5	Software	Supplier to provide full details of the industry standard software platform proposed
6	Back up	The back up/ recovery CD/USBs for all the software are to be provided with proper licensees on perpetual basis.

### C. Remote Access

- (i) It shall be possible to add a remote user terminal to provide access to the RF control system computer from a remote location via broadband network.
- (ii) The remote user shall have access to all the commands available at the main control system, subject to password restrictions for security.
- (iii) The remote user shall be presented with a user interface, which is identical to the local user interface.

### 5.4.5 Specification for Dehydrator :-

1. Dehydrator should be regenerative and should be able to provide suitable pressure to the entire waveguide run (existing + new, from KHPA system upto PDA ) waveguide run.
2. It should be rugged in construction and capable to handle the extreme climatic conditions.
3. The offered Automatic Dehydrator (Pressurization system) should have the provision for various alarms & indicators and safety valves.
4. Dehydrator, with required accessories, 3-5 PSI (user configurable) should be offered by the bidder.
5. Minimum required alarms, indications and safety requirement: Low pressure alarm, High pressure alarm, Pressure gauge, Adjustable pressure, High pressure safety release valve.

### 5.4.6 Specification for Waveguide:-

S. No.	Description	Specifications
(i)	Conductor Material	Copper/Copper Beryllium/ brass
(ii)	Operating Frequency Band	10 to 15 GHZ
(iv)	VSWR	≤1.1 at full freq. range
(v)	Attenuation	≤ 0.13 dB/feet
(vi)	Power handling capacity	≥ 1.5 KW

*Handwritten signatures and initials:*  
 [Signature] [Initials] [Signature]

### 5.4.7 Specification for Diplexer:-

#### A. Introduction

The Diplexer is an electrical operated four-port device.

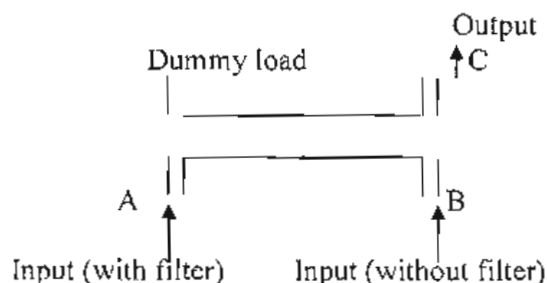

#### B. Specification

Sl. No.	Parameter	Specification
1.	Frequency Range	Port A to C : Centre frequency +/- 18 MHz Port B to C : 13.75 GHz to 14.5 GHz @ F0 +/- 1.5 Bandwidth or more
2.	VSWR (port A to C)	$\leq 1.15$
3.	VSWR (port B to C)	$\leq 1.15$
4.	Insertion Loss (port A to C)	$\leq 1\text{dB}$
5.	Insertion Loss (port B to C)	$\leq 0.3\text{dB}$
6.	Isolation (port A to B)	20 dB min. in operating band 40 dB min. other than operating band
7.	Isolation (port A to C)	20 dB min.
8.	Group Delay (port A to C)	4.0 ns max.
9.	Group Delay (port B to C)	2.5 ns max.
10.	Power Handling (port A to C)	2.5 kW min.
11.	Power Handling (port B to C)	6.0 kW min.
12.	Cooling	Forced Air
13.	Frequency pass band for port A	to be intimated once the frequency of operation is finalized

### 5.4.8 Specification for (1:2) IF Splitter

S. No.	Description	Specifications
(i)	Impedance	75 Ohm
(ii)	Connector	BNC
(iii)	Frequency	50MHz to 90MHz
(iv)	VSWR	1.3:1 or better
(v)	Isolation	28 dB or better
(vi)	Insertion loss	1 dB or better

#### 5.4.9 Specification for (1:2) RF Splitter/(2:1) Combiner:-

S. No.	Description	Specifications
(i)	Impedance	50 Ohm
(ii)	Connector	SMA
(iii)	Frequency	13.75 GHz to 14.50 GHz
(iv)	VSWR	1.3:1 or better
(v)	Isolation	15 dB or better
(vi)	Insertion loss	1 dB or better

#### 5.5 Specification for Monitoring system:-

The monitoring system has two parts:

- (a) Confidence level monitoring system
- (b) Input and downlink monitoring system of TV and Radio channels

A confidence level monitoring system consists IRDs with L-Band inputs, IRD with ASI input, IRD's with IP input, 64x64 SDI Router, 17" colour monitor, and 16 channel Audio Video Monitor etc. However, existing WFM will be used for confidence level Monitoring.

A confidence level monitoring system for 1 channel of each 8 carrier monitoring in Porta Cabin consists of demod with MPEG-2 TS over IP outputs, 16 channel multiviewer and 42 inch TV Set.

The input monitoring system of TV channel consists of IRDs with MPEG-2 TS over IP output, TV and Radio channel Multi Image Display System, 55" LCD Video Wall Display and associated accessories.

The downlink monitoring system consists of DVB-S & DVB-S2 de-mod with/and DVB-CAS Descrambler (Generic CAS), TV and Radio Channel Multi Image Display System, 55" LCD Video Wall Display associated accessories.

The specifications of main equipment of monitoring systems are given below.

##### 5.5.1 Specification of Confidence Level monitoring system

###### 5.5.1.1 Specification for 17 inch (Nominal) LCD (TFT/OLED) SD & HD Colour Monitor

###### A) ESSENTIAL FEATURES:

- i) The offered monitor should incorporate high intensity, high contrast wide screen 17 inch (Nominal), wide viewing angle LCD (TFT/OLED) Panel to view stable images from various angles: both horizontally and vertically, with no reduction in picture contrast, brightness and colour saturation.
- ii) The LCD (TFT/OLED) panel of the offered monitor should have resolutions of 1920 x 1080 pixels in 16:9 aspect ratio. The offered monitor should support 16:9 and 4:3 aspect ratios of the video signal. The monitor should also support 1920X1080/50I (HD) and 720X576/50I (SD) video formats.

*Handwritten signatures and initials:* DM, P, S, Shiner...

- iii) LCD (TFT/OLED) colour monitor should accept SD and HD SDI input (detected automatically).
- iv) The offered monitor should support embedded audio.
- v) The offered monitor should have 10-bit signal processing.
- vi) The monitor should have 1:1 pixel mapping to display the pictures in the original resolution (subject to the native resolution of the LCD (TFT/OLED) panel) and aspect ratio of the input signal without any stretch and distortion.
- vii) It should be possible for the user to select the industry standard colour temperature through menu for matching colours and gradation of the monitor.
- viii) The LCD (TFT/OLED) panel should be coated with Anti-Reflection protection layer to provide high transmission rate of the internal light source and to keep the reflection from ambient light to a minimum.
- ix) The monitor should have an external remote control capability via Ethernet, serial or similar interface.
- x) The monitor should be light weight, robust, compact and 19 inch rack mountable. It should have front panel controls to control the display parameters like brightness, contrast, colour saturation, audio etc.

#### B) Technical Specifications

Sl. No.	Parameter	Specification
1	Display Size	17 inch(Nominal) diagonally
2	Resolution	1920x1080 pixels or better
3	Colour reproduction	16 millions or better
4	Contrast ratio	300: 1 or better
5	Viewing Angle	150 degree (min.) in Horizontal 150 degree (min.) in Vertical
6	Brightness	250 cd / sq. m or better
7	Supported Aspect ratio	4:3 and 16:9
8	Video Input	HD & SD-SDI (BNC) x 2 or more
9	Audio input	Embedded Audio
10	Video Format	SD 720 x 576, 704 x 576, 544 x 576, 480 x 576, 352 x 576 1920X1080/50I (HD)

*[Handwritten signatures and initials]*

### 5.5.1.2 Specification for 16 Channel Audio/ Video Monitor

#### a) ESSENTIAL FEATURES:

- i) Audio/Video Monitor is to be used for confidence level monitoring of transmission chain at various points. Output of 64x64 SD/HD-SDI router will be fed to 16 Channel Audio/Video monitor Refer DRG No. 8.
- ii) The offered Audio/Video monitor should have high resolution LCD/OLED/TFT screen and support 1920X1080/50I (HD-SDI) and 720X576/50I (SD-SDI) video formats.
- iii) It should decode and display upto 16 channel multi format audio embedded with SDI simultaneously like Dolby Digital (AC-3) 5.1 audio, Dolby digital plus 5.1 (E-AC-3) audio, AES/EBU stereo channel for monitoring and metering.
- iv) The offered system should have multi channel audio bar graph and speakers and should not be overlaid on the video.
- v) It should be 19" rack mountable and have facility to monitor loudness and save minimum 5 preset configurations.

#### b) Technical Specification :

Sl. No.	Parameter	Specification
1	Video input format	a) SMPTE 259 M SD-SDI with embedded audio b) SMPTE 292 M HD-SDI with embedded audio
2	Embedded Audio on SDI	i) Dolby digital (AC-3) 5.1 audio, ii) Dolby digital plus 5.1(E-AC-3) audio iii) Dolby E iv) One Stereo AES/EBU
3	Video input quantity & type	2 nos., SD & HD-SDI input
4	Connector type	BNC, female
5	Audio input format	8 channel/ 4 stereo digital AES / EBU
6	AES and SDI termination	75 ohm unbalance
7	Level meter scaling	AES/EBU, VU
8	Level meter Parameter	Threshold, Reference, limits
9	Loudspeaker Power	12 W per speaker
10	Display Screen type & size	LCD/OLED/TFT, min 3.4 inch (diagonal) or better

*Handwritten signatures and initials:*  
 [Signature] [Initials] [Initials] [Signature]

### 5.5.1.3 Specification for Ku-Band (Downlink) to L-Band Down Converters

Sl. No.	Parameter	Specification
<b>A</b>	<b>INPUT CHARACTERISTICS</b>	
1	Frequency	10.70 GHz - 12.75 GHz
2	Return Loss (50 ohms)	10 dB minimum
3	LO Leakage	-70 dBm maximum
4	Signal monitor	-20 dBc nominal
<b>B</b>	<b>OUTPUT CHARACTERISTICS</b>	
5	Frequency	950 MHz - 1750 MHz for Ku--band
6	Return loss (50 ohms)	-14 dB minimum
7	Signal monitor	-20 dBc nominal
8	Power output (1 dB compression)	+15 dBm minimum
<b>C</b>	<b>TRANSFER CHARACTERISTICS</b>	
9	Gain	35 dB, $\pm 3$ dB
10	Gain stability	$\pm 0.25$ dB/day maximum at constant temperature
11	Amplitude response	(a) $\pm 0.5$ dB/40 MHz maximum (b) $\pm 2$ dB maximum over L-band
12	Image rejection	60 dB minimum
13	Noise figure	15 dB maximum
14	Intermodulation distortion (third order)	With two in band signals at 0 dBm output, third order intermodulation products are less than 60 dBc
15	Spurious outputs (in band)	
a	Signal related	60 dBc min at 0 dBm output
b	Signal independent	-70 dBm maximum Or -60dBc Minimum
16	Phase noise	IESS308/309 compliant
17	Frequency stability	$\pm 5 \times 10^{-8}$ , 0 to 50°C

am<sub>2</sub>    Lax    ✓    Jhimansha C



#### 5.5.1.4 Specifications for IF to L Band Up-converter (70 MHz to L-band)-

70 MHz to L-band Up-converter is to be used to check the monitoring output of modulators. Output of this Up-converter will be fed to IRD through RF Patch panel. The Specifications are detailed below:

S. No.	Parameter	Specifications
a)	Input Frequency	70 MHz $\pm$ 18 MHz
b)	Output Frequency range	950 MHz to 2150 MHz
c)	Input return loss	15 dB minimum
d)	Output return loss	15 dB minimum
e)	Phase Noise	IESS308/309 compliant
f)	Spurious	-55 dBc carrier related -65 dBm Non carrier related

#### 5.5.1.5 Specification for MPEG Decoder or IRD with ASI & IP input for SDTV & HDTV

This IRD shall be provided with DVB-ASI & IP input card having MPEG-2 & H.264/ MPEG-4 for SD-SDI with embedded audio, H.264/MPEG-4 & H.265/HEVC for HD-SDI with embedded audio and Dolby Digital 5.1 & Dolby digital plus 5.1 audio decoder. The specification remains the same as given in the para 5.1.3, except the fact that RF Specification parameter specification 5.1.3(A)(i), 5.1.3(A)(v), 5.1.3(B) & 5.1.3(C) are not applicable.

#### 5.5.1.6 Specification for 64x64 HD-SDI/ASI Routing Switcher

##### A. General:

The equipment should be very reliable and able to be used for selection of any one of the 64 HD-SDI/ASI input signals to all destinations. The equipment so offered should be for professional Broadcast applications. The Router has to be quoted with X-Y and Single Bus control panels.

##### B. Essential Features:

- i. The routing switcher electronics should be capable of being mounted in a standard 19" rack frame.
- ii. The switcher shall handle HD-SDI/ ASI signal for routing from input to output destinations. The switching should take place during the vertical interval period with re-clocking.

*Handwritten signatures and initials:*  
 [Signature] : [Initials]      [Signature] [Initials]

- iii. The switcher should have storage facilities for control information, so that in case of power supply failure, the status of the switcher output should remain unchanged when the power supply is restored.
- iv. The switcher should have a built in Auto-Switch able redundant power supply.
- v. The switcher quoted against this specification should be complete in all respects and should have the desired features.
- vi. Any of the 64input shall be capable of being switched to any or all of 64 outputs.

### C. Technical Specification:

Sl. No.	Parameter	Specification
1	Matrix size	64x64
2	Input	64 nos. HD-SDI/ASI ( BNC/HD BNC, 75 ohms)
3	Equalization	Automatic: 150 Meters at 270 Mbps.
4	Output	64 nos. HD-SDI/ASI (BNC/HD BNC, 75 ohm)
5	Return Loss	Should be maintained better than 15 dB up to 270 Mb/s throughout the switching chain.

### 5.5.2 Specification of Input Source and Downlink monitoring system

- a. The input source monitoring of all the 40 SDTV channels including 16 HDTV channels and 8 Radio channel of each stream will be done on Multi-image display system. All input signal of SDTV and HDTV channel will be available in MPEG-2, MPEG-4 & HEVC compressed MPEG-2 TS over IP format on RJ45. Whereas, input signal of Radio channel will be available on SDI with embedded Audio on BNC/HD BNC. It shall have the facility to decode and display SD & HDTV channels; and Radio Channel through RTMP, HLS, SRT IP streaming.
- b. The downlink signal monitoring of all the 40 SDTV channels including 16 HDTV channels and 8 Radio channel of each stream will be done on Multi-image display system. The downlink signal will be required to demodulate and descramble (CAS) the transport stream of all services (40 SDTV channels including 16 HDTV channels and 8 Radio Channels). The descrambled transport stream will be available in MPEG-2, MPEG-4 & HEVC compressed MPEG-2 TS over IP format on RJ45. It shall have the facility to decode and display SD & HDTV channels; and Radio Channel through RTMP, HLS, SRT IP streaming.

*Handwritten signature*

*Handwritten signature*

*Handwritten signature*

- c. There shall have the facility to decode and display SD & HDTV channels; and Radio Channel received through RTMP, HLS, SRT IP Streaming either through inbuilt Professional Broadcast Quality Multi Image Display System (Multiviewer) or through external Professional Decoder.
- d. Other physical topography is acceptable provided it meets scope of work and project objective.

#### 5.5.2.1 Specification for Professional Broadcast Quality Multi Image Display System for TV & Radio Channel

##### A. Features of Multi-Image Display System:

- a) The Multi-viewer system is meant for monitoring the input sources and Ku Band DTH downlink signals.
- b) Each set of offered product shall be of professional broadcast quality & is able to display up to 40 or more videos simultaneously along with the corresponding audio bar graph keyed into the video and 8 Radio Channel.
- c) Four sets of complete monitoring systems are required to be provided. Two sets monitoring system shall be configured for monitoring of input sources (40 SD including 16 HDTV and 8 Radio channel in each set) and another Two sets monitoring system for Ku Band downlink signals (40 SD including 16 HDTV and 8 Radio Channel in each set) available in IP format of 7<sup>th</sup> & 8<sup>th</sup> streams compressed in MPEG-2, MPEG-4 & HEVC format. (Please see DRG No. 9).
- d) The product shall facilitate selection of preset window layouts of various patterns and various sizes of video images.
- e) The system shall be flexible in terms of :
  - i) Control Multiple Screens
  - ii) Display the same source multiple times, in different sizes in the same or different modules.
  - iii) The system shall be capable of resizing the video signal and re-arranging the screen layout as per requirement.
- f) It shall be possible to display real time analogue and digital clocks as a substitute for any input signal into a display window.
- g) The offered product shall have the facility for labeling the displayed video source. The above features shall be selectable and removable depending upon the application.

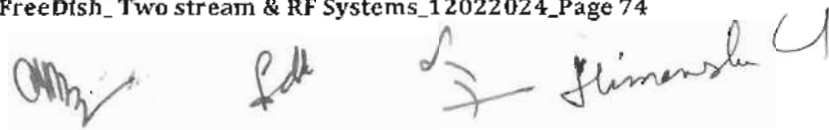
 The bottom of the page contains several handwritten signatures and initials in black ink. From left to right, there is a signature that appears to be 'AMZ', followed by the initials 'Pak', then a signature that looks like 'S. S.', and finally a signature that appears to be 'Srinivasulu' with a large 'U' to its right.

- h) It should support 4:3 and 16:9 aspect ratios and shall be able to configure for 4:3 or 16:9 aspect ratio instantly.
- i) It shall have SDI/DVI/XVGA/HDMI/DP or better output to feed the combined video to display monitor.
- j) The video output of multi-viewer shall be matched with the video input of the 55" display system, if not then matching adapter may be included in offer.
- k) The system should have one dedicated remote control panel (RCP) for easy, quick and user friendly access for recalling the required preset layouts, selecting full screen window, and selecting the audio source for monitoring etc. In case of software based RCP the required hardware (i.e. Desktop Computer with associated accessories) should be provided in the offer.
- l) The offered product should have the interfacing facility to connect an external PC for video layout configuring.
- m) It should have hot swappable dual redundant power supply.
- n) It should have 19" rack mounted main frame to accommodate inputs, outputs and other interfacing facilities.
- o) It should have facility to store/recall at least 10 nos. of preset layouts, window sizes etc.
- p) The offered solution shall be expandable.
- q) The system shall provide High Video Quality with Excellent scaling, Full Frame rate. The system shall have scalability of Sources Display Devices.
- r) The system shall log actions taken in a secured file and the system log should be available for export on SNMP. The Log should be kept for 7 days or more.
- s) The system shall provide customizable criteria for fault detection, alarm and reporting.
- t) The system/solution shall be able to detect and give (i) on screen alarms (ii) Audible alarms (like beep sound or tone) and (iii) log the following faults/errors :
  - i. Loss of video.
  - ii. Frozen video.
  - iii. Black video.

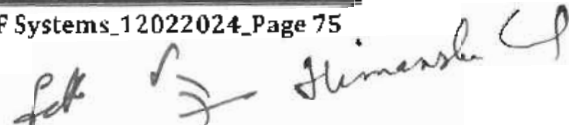

- iv. Loss of audio.
  - v. Audio level.
- u) There shall be a facility to add UMD for each and every input injected in the Video.
  - v) The system/solution shall have the facility to integrate multiple Multiviewer units and analyse all channels of stream 7<sup>th</sup> and 8<sup>th</sup> simultaneously and display Major & Minor alarms of all Input sources (at a time minimum 2 channels) in a separate monitor or main monitor having dedicated window.
  - w) The screen of separate monitor or dedicated window of main monitor shall be blank in case of no alarm is detected in the Input sources, whereas on the detection of alarm in any channel, the same channel shall be routed to this monitor or dedicated window of the main monitor.
  - x) The system/solution should have the facility to integrate multiple Multiviewer units and display the name of all channel/label multiplexed in stream 7<sup>th</sup> and 8<sup>th</sup> in one window on a remote monitor or dedicated window of main monitor. The colour of the channel name/label, displayed on remote monitor should be changed on acquisition of Major, Minor alarms and warning in any of the channel.
  - y) There shall have the facility to decode and display SD & HDTV channels; and Radio Channel received through RTMP, HLS, SRT IP Streaming either through inbuilt Professional Broadcast Quality Multi Image Display System (Multiviewer) or through external Professional Decoder.

#### B. Technical Specification of Multi Viewer/Image Display System Processor

Sl. No.	Parameter	Specification
1	IP Input Format	(i) MPEG 2 TS over IP (SPTS & MPTS) (ii) RTMP stream, HLS stream and SRT stream (if inbuilt in Multiviewer)
2	No. of IP Port	Minimum 4 Data ports (RJ 45), 1 Gbps min. And Minimum 2 Management ports (RJ 45)
3	DVI Input	Minimum 1 No. (either directly or suitable converter/Adopter).

*mm*

*feh*

*Shimshu*

4	SDI with Embedded Audio Input for Radio Service	Minimum 2 Nos. on BNC
5	SD-SDI Decoder from IP stream	i) SD MPEG-2 ii) SD H.264/MPEG-4 AVC
6	SD-SDI Video Resolution	720x576 704x576 544x576
7	HD-SDI Decoder from IP Stream	i) HD H.264 Main Profile Level 4.0 8 bit ii) HD H.264 High Profile Level 4. iii) HD H.265/HEVC Main Profile level 4.0 10 bit
8	HD-SDI Video Resolution	1920x1080
9	Decoding of Audio from IP Stream	i) MPEG-1 Layer-II ii) HE AAC V1 & V2 5.1 Audio iii) Dolby Digital AC-3 5.1 Audio iv) Dolby Digital Plus 5.1 E-AC-3 Audio
10	Video Output	SDI/DVI / X VGA/HDMI/DP
11	No of Video Output	Min 2 nos. ( Independent)
12	Operating Temperature	5 to 35 degree Centigrade
13	Humidity	10 – 90% non -condensing

#### 5.5.2.2 Specification for 16 Chanel Multi Viewer System for TV & Radio Channel

##### A. Features of Multi Viewer System:

- The Multi-viewer system is meant for monitoring the Ku Band DTH downlink signals.
- The offered product shall be able to display up to 16 or more videos simultaneously along with the corresponding audio bar graph keyed into the video and 8 Radio Channel.
- The Multi-viewer system is for monitoring of Downlink sources compressed in MPEG-2, MPEG-4 & HEVC format.
- The product shall facilitate selection of preset window layouts of various patterns and various sizes of video images.
- The offered product shall have the facility for labeling the displayed video source. The above features shall be selectable and removable depending upon the application.

- f) It should support 4:3 and 16:9 aspect ratios and shall be able to configure for 4:3 or 16:9 aspect ratio instantly.
- g) The video output of multi-viewer shall be matched with the video input of the 42" display system, if not then matching adapter may be included in offer.
- h) The offered product should have the interfacing facility to connect an external PC for video layout configuring.
- i) It should have hot swappable dual redundant power supply.
- j) It should have 19" rack mounted main frame to accommodate inputs, outputs and other interfacing facilities.
- k) It should have facility to store/recall at least 10 nos. of preset layouts, window sizes etc.
- l) The system shall provide High Video Quality with Excellent scaling, Full Frame rate. The system shall have scalability of Sources Display Devices.
- m) The system shall log actions taken in a secured file and the system log should be available for export on SNMP. The Log should be kept for 7 days or more.
- n) The system shall provide customizable criteria for fault detection, alarm and reporting.
- o) The system/solution shall be able to detect and give (i) on screen alarms (ii) Audible alarms (like beep sound or tone) and (iii) log the following faults/errors :
  - i. Loss of video.
  - ii. Frozen video.
  - iii. Black video.
  - iv. Loss of audio.
  - v. Audio level.

#### B. Technical Specification:

Sl. No.	Parameter	Specification
1	IP Input Format	MPEG 2 TS over IP (SPTS & MPTS)
2	No. of IP Port	Minimum 4 Data ports (RJ 45), 1 Gbps min. And Minimum 2 Management ports (RJ 45)

*[Handwritten signatures and initials]*

3	SD-SDI Decoder from IP stream	i) SD MPEG-2 ii) SD H.264/MPEG-4 AVC
4	SD-SDI Video Resolution	720x576 704x576 544x576
5	HD-SDI Decoder from IP Stream	i) HD H.264 Main Profile Level 4.0 8 bit ii) HD H.264 High Profile Level 4. iii) HD H.265/HEVC Main Profile level 4.0 10 bit
6	HD-SDI Video Resolution	1920x1080
7	Decoding of Audio from IP Stream	i) MPEG-I Layer-II ii) HE AAC V1 & V2 5.1 Audio iii) Dolby Digital AC-3 5.1 Audio iv) Dolby Digital Plus 5.1 E-AC-3 Audio
8	Video Output	SDI/DVI / XVGA/HDMI/DP
9	No of Video Output	Min 2 nos. ( Independent)
10	Operating Temperature	5 to 35 degree Centigrade
11	Humidity	10 – 90% non -condensing

### 5.5.2.3 Specification for DVB-S & DVB-S2 Demodulator

The demodulators will be used in downlink monitoring chain. The chassis should consist of multiple modules. The module should essentially meet the following specs:-

Sl. No.	Parameters	Specification
<b>DVB-S Demodulator</b>		
1	Standards:	EN 300 421 (DVB-S),
2	Input Frequency Range	950 - 2150 MHz
3	No. of Inputs per module	1 or more independently tunable
4	Decoding	RS
5	Symbol Rates	5 to 40 M symbol/sec for ( DVB-S)
6	FEC DVB-S	R= 1/2, 2/3, 3/4, 5/6, 7/8
7	LNB Signaling	LNB voltage + 22KHz continuous tone
8	LNB Voltage	0/13/18Volts
9	Connector:	F connector
10	Impedance:	75 ohms
11	Monitoring port	1 x ASI output on BNC or DVB-ASI over-IP.
12	Management	10/100/1000 Base-T Ethernet

*Handwritten signature*

*Handwritten signature*

*Handwritten signature*



DVB-S2 Demodulator		
1	Standards:	EN 302 307 (DVB-S2)
2	Input Frequency Range	950 - 2150 MHz
3	No. of Inputs per module	1 or more independently tunable
4	Decoding	LDPC and BCH
5	Symbol Rates	5 to 40 M symbol/sec for (DVB-S2)
6	FEC DVB-S2 QPSK	R= 1/2, 3/5, 2/3, 3/4, 4/5, 5/6, 8/9, 9/10
7	FEC DVB-S2 8PSK	R= 3/5, 2/3, 3/4, 5/6, 8/9, 9/10
8	LNB Signaling	LNB voltage – 22KHz continuous tone
9	LNB Voltage	0/13/18Volts
10	Connector:	F connector
11	Impedance:	75 ohms
12	Monitoring port	1 x ASI output on BNC or DVB-ASI over IP
13	Management	10/100/1000 Base-T Ethernet

#### 5.5.2.4 Specification of Demodulator with/and Descrambler

##### A. General Feature

- (i) Descrambler should receive the L band input and give multi service descrambling on to MPEG-2 TS over IP output.
- (ii) There should be vacant slot (CI slot) for descrambling of simulcrypt DVB-CAS (CAS) for all MPEG-2, MPEG 4 & HEVC and DVB-S & DVB S2 compliant services.
- (iii) It should be possible to configure and monitor the Descrambler through Remote PC.
- (iv) Descrambler should be able to generate and save logs for alarms and warning through Remote PC.
- (v) A separate unit of DVB-CSA (V1 & V2) supported DVB-CAS(CAS) descrambler shall also be acceptable.

##### B. RF Specifications

Sl. No.	Parameters	Specification
1	Input Frequency Range	950 - 2150 MHz
2	No. of Inputs	1 (min.)
3	Satellite Frequency Band	C- Band & Ku-Band, Selectable
4	Input Impedance	75 Ohms

*[Handwritten signatures and initials]*

5	Input Connector	F-Type female
6	Input Power Range	-30 to -60 dBm per carrier
7	LNB Voltage	13V, 18V or off, 22 kHz on/off
8	De-Modulation Method	DVB-S QPSK, DVB-S2 QPSK and 8PSK
9	Variable Symbol Rates	5.0 to 40 M Symbol /sec for (DVB-S) 5.0 to 40 M Symbol /sec for (DVB-S2)
10	Convolution Inner FEC selectable	R= 1/2, 2/3, 3/4, 5/6,7/8 (DVB-S, QPSK), R=1/2, 3/5, 2/3, 3/4, 4/5,5/6, 8/9, 9/10 (For DVB-S2, QPSK) R= 3/5, 2/3 , 3/4, 5/6,8/9,9/10 (DVB-S2 , 8PSK)

### C. Descrambler Specifications

Sl. No.	Parameters	Specification
1	DVB Descrambler	DVB-CSA (V1 & V2) supported DVB-CAS( Generic CAS)
2	No of services to be descrambled per CAM module/CI slot	Maximum 8 services
3	Free to air services	Pass through
4	Bit rate of per TS	65 Mbps
5	Total No. of Services to be descramble per stream	Minimum 40 TV services and 8 Radio services

### D. IP Transport Stream Outputs and Control Ports

Sl. No.	Parameters	Specification
1	Ethernet data port	1x 1000 Base T on RJ45 connector)
2	Output Format	MPEG-2 TS over IP
3	Ethernet Control port	1x 10/100 Base T (on RJ45 connector)

### 5.5.2.5 Specification for Industrial Type Professional Broadcast 55" LCD Video wall Display

Sl. No.	Parameter	Specifications
1	Size	55 inch or more
2	Backlit light	LED
3	Input	DVI, HDMI
4	Output	DVI
5	Resolution	1920x1080 or higher
6	Aspect ratio	16:9

*Handwritten signatures and initials:*  
 [Signature] [Initials] [Signature]

7	Viewing angle	Horizontal: 170 degree, Vertical : 170 degree
8	Luminance	$\geq 450$ cd/m <sup>2</sup>
9	Contrast	1200:1
10	Bezel Size	Maximum 2.0 mm/2.0 mm (Bottom/Right) Maximum 2.0 mm/2.0 mm (Top/Left)
11	Power consumption	400W Max
12	Operation Hours	24x7 Industrial Type
13	Mounting	Wall and stand Mounting type with mounting kit
14	Accessory	Power cord, DVI / HDMI Cable

## 5.6 Measuring Equipments

### 5.6.1 Specification for Real Time Signal Analyzer

#### A. Essential Features.

- i. The instrument shall be rack mountable, AC operated and supplied with all accessories like input probes, cables, Adapters and power cords etc.
- ii. The instrument shall have full set of marker functions including delta Marker, peak search marker, centre marker and multi marker ( $\geq 6$ ) etc.
- iii. The instrument shall have time and Data storage functions with internal memory to store minimum of 500 traces and 500 measurement setups.
- iv. The instrument shall be programmable for automatic measurements.
- v. The instrument shall have inbuilt self Test function or auto-calibration function.
- vi. The instrument shall have facility to display carrier in carrier.
- vii. The equipment shall have suitable software for transfer of screen shot measurement data to PC or Laptop.
- viii. The offered signal analyzer shall have over all accuracy of  $\leq 3.0$  dB.

Sr. No	Parameters	Specifications/Features
1	Frequency Range DC Coupled	9kHz to 26.5 GHz or better
2	Aging Rate	$\leq 1 \times 10^{-7}$ / year
3	Temp, stability (5 to 40deg.C)	$\leq \pm 5 \times 10^{-8}$

*[Handwritten signature]*

*[Handwritten signature]*

*[Handwritten signature]*

4	Frequency span	0 Hz - (Zero Span), 1KHz to 26.5GHz or Better.
5	Minimum Acquisition Bandwidth	100 MHz
6	Spurious-Free Dynamic Range	-70 dBc or better Or 100dB or Better
7	Displayed Average Noise Level (With Pre Amp. On)	Better than -150dBm/Hz for entire range of frequencies from 10MHz to 26.5 GHz
8	SSB Phase Noise at 1GHz frequency	10kHz offset: <-102dBc/Hz 100kHz offset: <-107dBc/Hz
9	Third order intercept point	Better than +15dBm across specified frequency range
10	RBW and VBW	1Hz to 3MHz (3dB), in 1-3 sequence or 1Hz to 3MHz (3dB), (10% steps), 4, 5, 6, 8 MHz
11	Spectrum Display capabilities	(a) Display transients of a minimum event duration of 6µsec length shall be displayed in the frequency domain with span up to acquisition bandwidth (b) Spectrum computation of >250,000 FFTs per second (c) Shall provide an understanding of Time-varying RF signals with colour-gradation based on frequency of occurrence. (d) shall have persistence feature to capture rare interference kind of rare events and retain all updates on the screen with colour gradation
12	Trigger capabilities	Modes: Free Run, Triggered-Continuous or Single. Sources: RF input, External Trigger input Position: Settable from 0 to 100% of total acquisition length
13	Acquisition Length/Time	Min. 5 msec to 5 sec at Acquisition Bandwidth or Equivalent

14	Spectrogram Display	(a) Spectrogram shall be available. (b) 3-D view of the spectrogram to view captured signal is required
15	Modulation Analysis	<p>Modulation Types: DVBS(QPSK), DVBS2 (8PSK), 16QAM, 64QAM, 256QAM.</p> <p>Numerical Measurements: Error Vector Magnitude (EVM) (RMS, Peak), Modulation Error Ratio (MER), Magnitude Error (RMS, Peak), Phase Error (RMS, Peak), Origin Offset, Frequency Error, Gain Imbalance, quadrature Error,</p> <p>Displays: Constellation Diagram, EVM vs. Time, Magnitude vs time, Phase error vs time, Demodulated IQ vs. Time, Symbol Table (Binary or Hexadecimal), , Eye Diagram, Trellis Diagram, Frequency Deviation vs. Time</p> <p>1 kS/s to 100 MS/s for up to maximum Acquisition Bandwidth Shall have carrier tracking capability inside acquisition bandwidth for continuous demodulation</p>
16	Frequency domain Measurements	Channel Power, Adjacent Channel Power, Occupied Bandwidth, dBm/Hz Marker, dBc/Hz Marker, Burst Power
17	Time domain & Statistical measurements	<p>Amplitude vs. Time, Frequency vs. Time, Phase vs. Time, Amplitude Modulation vs. Time, Frequency Modulation vs. Time, Phase Modulation vs. Time, RF IQ vs. Time, Time Overview</p> <p>Statistical: CCDF, Peak-to-Average Ratio</p>

18	Automated Pulse Measurements	Time & Power measurements: Average-On Power, Peak Power, Pulse Width/Pulse Duration , Repetition Interval (Hz)/ Pulse Period, Duty Factor (%) etc
		Pulse-Pulse Measurements
		Displays: Pulse Statistics/Characteristic
19	Display	Integrated TFT Colour display with Touch screen interface. (internal/external)
20	User Interface and Memory	Windows OS with Mouse and keyboard interfaces. Ethernet or LAN -RJ45 & USB port connectivity Internal HDD to store IQ data, set-up files etc.

### 5.6.2 Specification for Spectrum Analyzer

A	Essential Features
i)	The instrument should be bench top, rack mounted model, AC operated and supplied complete with all accessories like input probes, Cables, Adapters and power cords, etc.
ii)	The instrument should have full set of marker functions including delta Marker, peak search marker, Zone marker, centre marker, multi marker ( $\geq 6$ nos) and features like Spectrogram, Zoom/Zone Span.
iii)	The Instrument should have time and Data storage functions with internal memory to store minimum of 500 traces and 500 measurement setups.
iv)	The instrument should have remote control operation facility and should be programmable for automatic measurements with pre installed operating System preferably Windows.
v)	The instrument should have auto-calibration function.

vi)	The Spectrum Analyser should be capable of making following measurements and display results:
a)	Noise power (in dBm / Hz or dBm/ Ch.)
b)	C/N (in dBc/ Hz or dBc/ Ch.)
c)	Occupied Band Width and Adjacent channel power
d)	Average power of burst signal
e)	Spurious Emission
g)	Frequency Counter (min. resolution: 0.001Hz)
h)	2-tone, 3 <sup>rd</sup> order intermodulation distortion
i)	Power vs. Time, Frequency vs. Time, Phase vs. Time, CCDF, Amplitude Probability Distribution, Spectrogram
k)	Spectral Emission Mask with Limit Lines
l)	Offered Spectrum Analyser should be able to analyse DVB-S(QPSK) , DVB-S2(8PSK) Modulations as used for satellite communication at Earth Stations. It should be able to provide following measurement trace modes for:  -Constellation, EVM vs Symbol, Equalizer Amplitude, Equalizer Phase, Equalizer Group Delay, Equalizer Impulse Response, Custom Numeric, Magnitude Error vs Symbol, Phase Error vs Symbol, Frequency vs Symbol, Trellis, Eye Diagram, Numeric, I and Q vs Symbol, Magnitude vs Symbol, Phase vs Symbol, Signal Monitor, Symbol Table & others.  Software provided if any for the above measurements should be perpetual license with free upgrades during warranty period and for entire life time of the equipment
vii)	Spectrum Analyser should have superior XGA coloured LCD/TFT Display 8 inch or better.
viii)	The equipment should have internal (built-in) hardware and software for transfer of screen shot measurement data. USB & Ethernet/ LAN port should be provided for the remote control operation and connecting peripherals like Keyboard and printer or external PC/Laptop.

**B) Technical Specifications:**

1	<b>Frequency Range (DC coupled)</b>	9KHz to 26.5GHz or better
a)	Aging Rate	$< 1 \times 10^{-7}$ / year
b)	Temp. stability (5 to 40deg.C)	$\leq \pm 5 \times 10^{-8}$
c)	Frequency span	0 Hz - (Zero Span), 1KHz to 26.5GHz or Better.
2	<b>Spectral Purity</b>	
a)	SSB Phase Noise @ 100KHz offset	-107 dBc/Hz @ 1GHz or better

3	<b>Bandwidths</b>	
a)	Resolution Bandwidth (3dB)	1Hz to 3MHz (3dB), in 1-3 sequence or (10% steps), 4, 5, 6, 8 MHz
b)	Video Bandwidths	1 Hz to 3MHz, in 1-3 Sequence or (10% steps), 4, 5, 6, 8 MHz
c(i)	Analysis Bandwidth	1KHz to 40MHz or better
c(ii)	Sampling Rate	50MHz or better
4	<b>Amplitude</b>	
a)	Max. Input level(continuous)	+30 dBm or better (Suitable external Attenuator can be provided to meet this requirement, if required.)
b)	Third Order Intercept Point	+12 dBm or better across specified frequency range
c)	Displayed average noise level at 0dB attenuation (RBW 10 Hz and 10 Hz VBW) at 25 GHz or Higher frequency	$\leq -134\text{dBm/Hz}$
d)	RF input attenuation range	0dB to 60 dB in 2 dB steps (manual or automatic).
e)	Input Connector/ impedance	N type/50 ohm
f)	Total Absolute Amplitude Accuracy	$\leq 1.0\text{dB}$ (Frequency @ 3GHz); $\leq 4\text{dB}$ @ 25GHz
5(a).	Sweep Trigger	Free run, Video, External
5(b).	Swcep Time	1ms to 1000 Sec( Span> 1KHz) 1 $\mu\text{s}$ to 1000 Sec (Span = 0Hz) or time domain mode
6	<b>Display</b>	
a.	Modes	Normal, Max/Positive Peak, Min./negative Peak, Average, RMS etc.
b.	Scales	Log Scales-dBmV, dB $\mu\text{V}$ , dB $\mu\text{V/m}$ , dBm, Linear Scale-V 1dB/div to 10dB/Div. in suitable steps.
7	<b>Interface</b>	
		Ethernet or LAN -RJ45 & USB port.

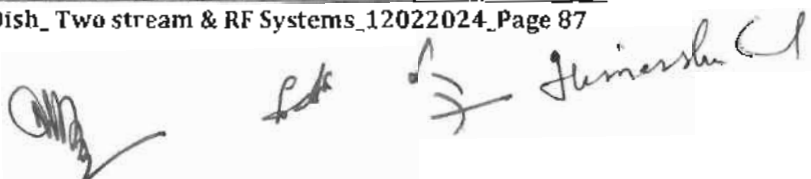



<b>8</b>	<b>Accessories</b>	<p>a) Standard accessories including Low Loss Test Port extension Cable (Min. 1 mtr length with suitable connectors &amp; adoptors (if required) ) to connect with the RF IN port of Spectrum Analyser should be supplied from OEM.</p> <p>Optional accessories shall be offered to complete all the measurement applications. Additional items to be offered if required</p> <p>b) Internal Memory 40 GB or Higher.</p>
----------	--------------------	--

### 5.6.3 Test, measuring and maintenance equipment for Optical Fiber and Ethernet link (copper) system-

The test, measuring and maintenance equipment for Optical Fiber and Ethernet link (copper) system should consist of following equipment along with their essential accessories like RJ45-RJ45 patch cord, charger, RJ45/11 universal coupler, required probes, 1310/1550 single-mode source, SC, ST, and LC power meter adapters, carrying case etc -

#### 5.6.3.1 Micro-Fiber Optic end face Inspection Scope

##### Features-

- (i) The Fiber Inspection Scope Camera should be able to verify the Fiber End Faces are not contaminated or damaged.
- (ii) The equipment should have a built-in flashlight to illuminate dark areas and dense panels.
- (iii) The Fiber inspection scope camera should have the autofocus for stable images in few seconds.
- (iv) The equipment should have large display to view single mode and multimode fiber end face.
- (v) The equipment should be able to works on patch cords and bulkhead connectors.
- (vi) The equipment should support wide range of tips to support most industry standard connectors.

*Handwritten signatures and initials:* [Signature] [Initials] [Signature] [Signature]

- (vii) The equipment should have the feature of capture & zoom to see small particles.
- (viii) The equipment should have rugged construction; vibration and hold drop tested to 1 meter.
- (ix) The handheld test kit should be supplied in a professional and durable case.

#### 5.6.3.2 Cleaning kit

##### Features-

- (i) The cleaning kit should support complete solution for precision end-face fiber optic cable cleaning.
- (ii) It should clean all fiber connector types and easy to use cleaning kit with no special training required.
- (iii) Solvent pen precisely dispenses specially formulated fiber optic cleaning solution.
- (iv) .It consist Optical Fiber Cable (OFC) cleaner cards for convenient cleaning of fiber end-faces.
- (v) It should support Fiber Optics Connectors of SC;ST;FC;LC.
- (vi) The solvent in the fiber cleaning pen should have a lower surface tension that allows it to envelop particles and debris, effectively lifting them the surface of the end-face as they are carried away by a fiber wipe or swab.
- (vii) The cleaning kit should support with lint-free cleaning strand to ensure the end faces remain as clean as possible.

#### 5.6.3.3 Optical Power meter for Multimode and single mode.

##### Features-

- (i) Optical Power meter should do measurement for single mode and multimode.
- (ii) It should allow for a non-touch solution to check for a live fiber without having to plug into ports.

*Handwritten signature*

*Handwritten signature*

*Handwritten signature*

*Handwritten signature: Himanshu C*

- (iii) The optical power meter should be calibrated for accuracy for different wavelength like 850, 1300, 1310, 1490, 1550, 1625 nm.
- (iv) The automatic wavelength-sensing feature of the meter should identifies the source wavelength and sets itself appropriately.
- (v) The meter should have the ability to save a reference power level, allowing a direct display of fiber loss.
- (vi) The meter should have a large LCD display screen, and a USB port to upload test results to a PC.
- (vii) It should have facility of easy cable-routing identification with the help of some associated tool.

#### Technical specification-

1	Optical Connector	SC;ST;FC;LC (Interchangeable cable with suitable adpoter is acceptable)
2	Emitter Type	850/1300 : LED 1310/1550 : FP Laser Finder Fiber : Laser
3	Emitter Wavelengths (nm)	850, 1300, 1310, 1490, 1550, 1625
4	Power Output (dBm)	-20
5	Power Output Stability (8 hours)	±0.1 dB over 8 hours
6	Power Measurement Accuracy	±0.25 dB
7	Optical Connector	Removable Adapter
8	Detector Type	InGaAs
9	Calibrated Wavelengths	850, 1300, 1310, 1490, 1550, 1625
10	Power Measurement Range	850nm : 10 to -52 dBm 1300, 1310, 1490, 1550, 1625nm : 10 to -60 dBm
11	Resolution	Better than 0.01 dB
12	Battery Life	> 50 hours typical
13	Serial communication physical interface	USB

#### 5.6.3.4 Portable handheld Ethernet tester

##### Features-

- (i) The tester shall be able to Quickly test, verify and troubleshoot wired networks.
- (ii) The tester should be able display graphical wire map and length test to identify common faults that occur with cabling installation.
- (iii) The tester shall have touch Sensitive gesture-based display for ease of operation.
- (iv) The tester shall support the blink Port light on switch to help and identify the connected switch port.
- (v) The tester shall be able to test connectivity to TCP/IP network through IP configuration and ping.
- (vi) The tester shall be able to test and support diagnostic Protocols Link Layer Discovery Protocol (LLDP) , Fast Link Pulses (FLP) etc.
- (vii) The tester shall be able to verify Gateway and DNS server responsiveness and availability.
- (viii) The tester shall be able to Install and troubleshoot PoE devices via Switch Negotiation and PoE Load test. Ethernet Alliance PoE Certified for reliable multivendor interoperability.
- (ix) The tester shall support 10G performance testing.
- (x) The tester should support media access for copper 10M/100M/1G/2.5G/5G/10G.
- (xi) The tester shall have inbuilt Rechargeable lithium-ion battery pack.
- (xii) The tester should be able support active diagnostics with basic details like switch name, port number, VLAN name, advertised data rates and advertised duplex.
- (xiii) The tester shall have USB Type-A Port and USB Type-C.
- (xiv) The tester shall support cable type Balanced twisted-pair cabling, Unshielded twisted- pair, Screened twisted-pair, 2-pair and/or 4-pair.
- (xv) The tester shall support PoE 802.3af/at/bt, Class 0-8 and UPOE.

The bottom of the page contains several handwritten signatures and initials. From left to right, there is a signature that appears to be 'S. S.', followed by 'S. S.', then a checkmark and the name 'S. S.', and finally a signature that appears to be 'S. S.' with a circled 'S' next to it.

- (xvi) The tester shall support cable tests with pair lengths, opens, shorts, split-pairs, crossed, straight through, and wireview.
- (xvii) The tester shall Support Industrial Ethernet (EtherNet/IP, PROFINET, EtherCAT, and others).
- (xviii) The tester should support and generate Analog or Digital tones compatible with any industry standard toner to assist in locating cables in a wall or telecommunications room.
- (xix) The tester shall support maximum length of 250 Meters.
- (xx) The tester shall support Wire Map, length of each pair, Diagnose split pairs. User selectable crossover settings (Straight through, Half-crossover, Full-crossover).
- (xxi) The tester should support on board result storage capability for up to 500 readings.
- (xxii) The tester must be supplied with remote unit, Toning Probe, USB-C to USB-A cable, charging cable (with international adapters), Cat 6A patch cord, RJ45/11 Modular Adapter, hanging strap and carry Bag.

#### 5.6.3.5 Fiber Optic Splicing Machine along with relevant KIT.

##### A- Features-

- (i) Fiber Optic Splicing Machine allows the operator to prepare minimum one fibers for fusion splicing.
- (ii) It should have movable min. 4-inch color LCD monitor to ensure optimum visibility in a range of conditions, even when outside under direct sunlight.
- (iii) It should equipped with a mechanism linking the wind protector and fiber clamp so when wind protector opens, the fiber clamps open automatically.
- (iv) It should equipped with retention clamps.
- (v) It should have required accessories like splice protection sleeves packet (consist of min 1000 Pc).

##### B- Technical Specification

Description		Specification
Fiber alignment method		Active clad alignment
Fiber count can be spliced		Single fiber
Applicable fiber	Fiber type	Single mode optical fiber
		Multi mode optical fiber
	Cladding dia.	125µm (Typical)

*[Handwritten signature]*

*[Handwritten signature]*

*[Handwritten signature]*

Applicable coating	Sheath clamp	Coating dia.:Max.3000µm Cleave length: 5 to16mm
Fiber splice performance	Splice loss	ITU-TG.652:Avg. 0.03dB
		ITU-TG.651:Avg. 0.01dB
		ITU-TG.653:Avg. 0.05dB
		ITU-TG.655:Avg. 0.05dB
		ITU-TG.657:Avg. 0.03dB
	Splice time	Avg. 6 to 8 sec.
Applicable Protection sleeve	Sleeve type	Heat shrinkable sleeve
	Sleeve length	Max.66 mm
	Sleeve dia.	Max.6.0 mm before shrinking
Sleeve heat performance	Heat time	60 mm mode: Avg. 25 sec.
		60 mm slim mode: Avg. 20 sec.
Fiber tensile test force		2.0N (Typical)
Electrode life		6,000 splices (Typical)
AC adaptor	Input	AC100 to 240V,50Hz, Max.1A
Battery	Type	Rechargeable Lithium Ion
	Output power	3000 mAh(min)
Display	LCD monitor	TFT 4 inches (min) with touch screen
	Magnification	150 to 300x
Illumination	V-grooves	LED lamp
Interface	PC	USB 2.0 Mini B type
	External LED lamp	USB2.0 A type Approx. DC5V, 500mA
	Wireless	Bluetooth
Data storage	Splice mode	Min 80 splice modes
	Heat mode	Min. 25 heat modes
	Splice result	Min. 15,000 splices
	Splice image	Min. 90 images
Other features	Automatic functions	Fusion control
		Blade management and control
	Sheath clamp	Open with/without Wind Protector
		Close with fiber setting
		Easy sleeve positioning clamp
Electrode	Replaceable without tool	

## 5.7 Specification of Power Supply System

The Power Supply System consists of the following equipment:-

- a. Sub distribution Board(SDB) for power distribution to the various equipment chain.
- b. Suitable earthing for the power supply system.
- c. 4 core & 3 core copper Power Supply Cables of various rating
- d. Mains Distribution Unit

### 5.7.1 Specification for Sub Distribution Board

Suitable Sub Distribution Board (SDB) must be supplied and installed which will distribute the AC power to each rack of the Input Baseband System, Compression , Monitoring system and RF System. The suggestive block schematic is given for general idea about the configuration of SDBs (Please refer DRG No.10). Bidder shall submit schematic diagram in advance before installation for approval.

### 5.7.2 Earthing System

- a. Earth pits should consist of Copper Earth electrode (diameter 20 mm (min)), insulated copper strip/wire (75 Sq. MM (Min)), Chemical earth fill compound with fast discharge characteristics, water absorbing gel, perforated Hard HDPE pipe (diameter 40 mm (min)), funnel, water supply provision upto each earth pit (preferably from A/c condenser), 10 feet depth (min) and 1 feet diameter (min.). Earth pit should be prepared so that earth resistance is less than 1 ohms –typical depth of earth pit is 10 feet minimum. (Sample picture is enclosed at DRG No. 12).
- b. All earth pits shall be extended upto earth terminals mounted on wall with insulated copper strip (75 Sq.mm (Min)) in their respective equipment room i.e. old Compression room & Porta Cabin. All equipment rack of each row shall be directly connected to Earth Terminals with insulated multi strand copper wire (25 sq mm (Min)) with copper lugs at both ends.

### 5.7.3 Specification for Mains Distribution Unit (MDU):

#### A. General Features

- i) Equipment shall operate from a wide range of power supply voltages without interruption or damage.

*akm*

*for*

*3*

*Shimshu*

- ii) Every rack should have minimum two sets of Mains Distribution Units (MDUs), each having, inbuilt with MDU or external, dual input, single phase automatic power transfer/static switches. Each MDU shall have sequential delayed output start up, output status LED and IEC-3 pin for each equipment installed in the rack. (Please refer DRG No: 10 & 11).
- iii) All Equipment which have dual power supply unit shall be connected directly from MDUs. (Please refer DRG No: 10 & 11).

### B. Technical Specification

Sl. No.	Parameter	Specification
1	No. of fused outlets with IEC 3-Pin Connectors in each MDU	12 nos. or more
2	Primary Power Supply	220/240 V AC nominal, Single phase, (50 +/- 2 )Hz
3	Current (Max)	16 Amp

## 6 COMPLEMENT OF EQUIPMENT:

- a) The make and model/part no. of each and every equipment/item/installation material etc. should be clearly mentioned in the offered Bill of Material (BOM).
- b) The suggestive Bill of Material (BOM) has been provided in **Annexure-I of Appendix-D**. The bidder is required to provide the complete list of equipment, software and accessories etc. offered to meet the requirement as per DD specifications. The quantity of each item including sub-module, licenses etc. are to be specified clearly and compulsorily, failing which the bid is liable to be rejected summarily. The following is the proforma for the BOM:

Sr. No.	Description of the item as per specification (suggestive BOM)	Description of items offered by bidder	Quantity as per suggestive BOM	Quantity offered by the Bidder	Make Offered	Model Offered
1.	2.	3.	4.	5.	6.	7.

- c) The bidder should provide the offered un-priced Bill of Material in electronic form with the priced bid for ease of technical evaluation.

*Chm*

*Lok*

*7*

*Shimansh C*





- b) In addition to the above, compliance from respective OEMs (not from their Indian representatives) in respect of the equipment as listed below should necessarily be given, in respect of all the points, sub-points and paras laid down in the Technical Specification of the respective equipment in the format as given above. The OEM should necessarily record the performance figure of the equipment offered in the quote for which the compliance statement is required.

<b>A</b>	<b><u>Input and Base Band System</u></b>
1.	<u>Dual/Single Channel L Band Amplifier</u>
2.	64x192 L Band Router
3.	Integrated Receiver Decoders (IRDs)
<b>B</b>	<b><u>Digital Compression System</u></b>
1.	64x64 SDI Router
2.	Encoder
3.	IP Encapsulator cum Multiplexer
4.	16x16 ASI/SDI Router
5.	Network Management system (NMS)
6.	IP Data Switch
7.	Optical Fiber Communication link system
8.	3G/HD/SD SDI, DVB/ASI Compliant Distribution Amplifier system
<b>C</b>	<b><u>Satellite Modulator</u></b>
1	Digital satellite Modulator
2	IF Redundancy Switch
<b>D</b>	<b><u>RF System</u></b>
1.	Ku Band Up convertor
2.	RF Redundancy Switch
3.	Klystron High Power Amplifier (KHPA)
<b>E</b>	<b><u>Input Source &amp; D/L Monitoring system</u></b>
1.	Demodulator with/and Descrambler
2.	Multi viewer
3.	64x64 ASI/SDI Router
4.	16 Channel Audio/Video Monitor
5.	Professional Broadcast 55" LCD (LED/OLED) Video Wall Display
6	Ku to L Band Down convertor
7	IF to L Band Up Converter
<b>F</b>	<b><u>Measuring Equipment</u></b>
1.	Real Time Signal Analyser
2	Spectrum Analyser
3	Optical Power meter
4	Micro-Fiber Optic end face Inspection Scope
5	Portable handheld Ethernet tester
6	Fiber Optic Splicing Machine

*[Handwritten signatures and initials]*

- c) Mere signature on a copy of Doordarshan specifications shall not be accepted as a compliance statement.
- d) The compliance statement in respect of Technical Specifications of the equipment should be supported by highlighted record of these in the relevant technical literature/data sheets of respective equipment enclosed with the tender and a clear reference (with volume number and page number of tender documents) to the attached supporting document should be given in the remarks column against each & every specs. Any offer without proper supporting document of each & every specs and containing only a commercial hand out/pamphlet is liable to be rejected.
- e) Data sheets in respect of all offered equipment should be submitted. Any deviation from the specification detailed in the compliance statement is to be highlighted separately. Page no. of location of data sheet should be given in page no. column of the compliance statement.
- f) Offers without proper & duly completed compliance statement are likely to be rejected with the sole responsibility of bidder and no further claim/correspondence will be entertained.
- g) The bidder is also required to submit authorization in respect of the equipment as listed above at Sl. No. 8.1(b) in their favour from respective OEMs (not from their Indian representatives) on their letter heads along with the bid as **prescribed in Annexure II of Appendix-D.**

## 8.2 Documentation:

- a) One set of technical manual for all the equipment are to be provided along with the tender to facilitate the technical evaluation, otherwise the tender is liable to be ignored.
- b) The successful bidder will have to supply set of printed technical & user manuals along with factory test report of all the offered equipment.
- c) Operation Manual for all equipment should also be supplied on DVD/USB storage with search facility.
- d) All offered software should have perpetual validity and should be in the name of Doordarshan. All software backups should also be supplied on DVD/USB storage.
- e) For facilitating maintenance issues, the bidder must submit the firm's self certified copies of Bill of Entry/Bill of Laden/Custom Invoice of all imported items to DG:DD.
- f) The successful bidder must ensure that all Invoices bear serial numbers of equipment to meet the requirement of WPC.

*AMM*

*Full*

*2* *Shimshu*

- g) The successful bidder must submit the firm's self-certified copies of import license at the time of commissioning in respect of RF Equipment for issuance of operating license from WPC.

**8.3 Guarantee/Warranty, Material & workmanship and After Sales Service Support:**

**8.3.1** The Guarantee, warranty of material and workmanship will be covered by General Terms and Conditions (GTC) at APPENDIX-B of the Bid document except the following:

- a) All the offered equipment shall be guaranteed against any manufacturing defect for a period of 5 (Five) years from the date of Commissioning.
- b) Any part failing during the guarantee period shall be repaired/replaced free of charge by the successful bidder at site. For repairing of any defective equipment during guarantee period, the defective module or equipment requiring repairs will be handed over to local office/local authorized representative/ dealer who will arrange repairs locally at site or send/export the defective modules to OEM factory and re-import/send back after repairs.
- c) It is the responsibility of local office/ Authorized representative/ dealer of the bidder to arrange the repair/ replacement of faulty items for Doordarshan i.e. no transportation charges would be paid by DD for transporting the defective/ repaired items, if required to be removed from site, during the guarantee period.
- d) Guarantee period of Equipment or spare parts thereof replaced is to be extended corresponding to the outage period from the date of acceptance, if the failure rectification takes more than 30 days time.
- e) If bidder is not the OEM, then the guarantee/ warrantee in respect of the equipment as mentioned in Clause 8.1(b) shall be provided by the bidder through respective OEMs. A certificate, duly signed by the OEM on the OEM letterhead, in this regard of the respective equipment must be submitted with the offer by the bidder as prescribed in **Annexure III of Appendix D.**
- f) If bidder is not the OEM, then after sales service support for additional 2 (Two) years for the repairs/ maintenance in respect of the equipment as mentioned in Clause 8.1(b) after the completion of guarantee/ warrantee period shall also be provided by the OEM either directly or through his representative in India. A certificate, duly signed by the OEM on the OEM letterhead, in this regard of the respective equipment must be submitted with the offer by the bidder as prescribed in **Annexure IV of Appendix D.**

#### 8.4 Inspection and Commissioning:

The inspection of material will be carried out by the authority specified in the Purchase order. The material will be accepted only after the same has been found satisfactory after inspection and duly marked and sealed by the Inspection Authority. In addition to "General Terms and Conditions" (GTC) at Appendix-B of the Bid document, the inspection of material/equipment will be carried out as follows:

- 8.4.1 All the equipment to be supplied against this A/T (Purchase Order) for this tender shall be subjected to pre-installation inspection at Doordarshan Site by Doordarshan Officer appointed by Doordarshan Directorate. The pre-installation inspection shall be based on manufacturer's factory test results and physical verification of make and model of equipment. The successful bidder should produce the factory test reports of the offered equipment to facilitate inspection.
- 8.4.2 Post installation inspection and commissioning of the system will be carried out by a team of Doordarshan Officers authorized by Doordarshan Directorate and based on approved Acceptance Test Procedure (ATP).
- 8.4.3 A draft copy of ATP (Acceptance Test Procedure) must be submitted by the successful bidder one month in advance of the proposed date of inspection of the installed system to Doordarshan Directorate for approval. ATP should describe the standard test procedure of individual equipment and overall system. The factory test report will not be treated as ATP.
- 8.4.4 The approved ATP with or without changes shall be sent back to the successful bidder to be used for inspection and commissioning of the installed system by DD Engineer(s) at site. All the equipment required for the inspection as per the approved ATP are to be provided by the successful bidder.
- 8.4.5 The SITC certificate will be issued by the team of Officers appointed at S.N. 8.4.2 above

#### 8.5 Delivery Period:

Six months from the date of issue of purchase order(A/T) by Doordarshan to the successful bidder.

*am*

*let*

*2*

*Shimashu CP*

**8.6 Pre-Bid Conference:**

A pre bid conference on technical Specifications and other issues shall be held on date and time specified in the NIT. All prospective bidders may attend the pre bid conference to discuss their queries and suggestions. All the queries and suggestions should be sent to Doordarshan at least 2 days before the date of pre bid conference. No queries/ suggestions shall be entertained after pre bid conference. Amendments subsequent to the pre bid conference shall be sent to prospective bidders, who have purchased tender document by e-mail/fax/ post. It shall be bidder's responsibility to check for any amendments on Doordarshan website before submitting their duly completed bids.

**8.7 Check List and Enclosures:**

The bidders may ensure the following check list while submitting the bid including some important list of enclosures for ease of technical evaluation along with list of enclosures mentioned in Appendix-A, Appendix-B, and Appendix-C of Tender Bid.

(Additional Check List)			
	Description	YES/NO/NOT APPLICABLE	Remarks
1	Whether documents related to fulfilment of the eligibility criteria for Bidder and OEMs as per Clause 3 have been submitted ?		
2	Whether the BOM has been submitted in the prescribed format as given in Clause 6 ?		
3	Whether all equipment and accessories as given in Annexure-I of Appendix-D have been included in the offered BOM ?		
4	Whether the compliance statement from the bidder as required in Clause 8.1 (a) has been submitted ?		
5	Whether the compliance statements from the respective OEMs for equipment/system mentioned in Clause 8.1 (b) have been included ?		
6	Whether the Authorization (Annexure-II of Appendix-D) as required vide clause no. 8.1(g) in respect of equipment as mentioned in Clause 8.1 (b) from respective OEMs have been included ?		
7	Ensure that the relevant technical brochures/manuals containing all the parameters of technical specifications of all the offered equipment and accessories have been included with proper indexing for ease of identification ?		

8	Whether the page numbers of the relevant enclosed technical data sheet/manual against each parameter of the technical specifications have been given in the compliance statements ?		
9	Whether the requisite undertakings for guarantee/warranty (Annexure-III of Appendix-D) and after sales service support (Annexure-IV of Appendix-D) by OEMs as required vide Clause no. 8.3 have been submitted ?		
10	Whether the requisite undertakings as required by Annexure-V of Appendix-D and Annexure-VI of Appendix-D by Bidder have been submitted ?		
11	Ensure that no alternate item has been offered		
12	Ensure that the Un-priced BOM has been included		
13	Any other item mentioned elsewhere in the tender.		

*am*

*Feb*

*2*

*Shimanshu*

Annexure II of Appendix-D

**OEM LETTER HEAD**

**CERTIFICATE FOR AUTHORIZATION**

Date:

Tender No. :

We, M/s ..... (Name and Address of the OEM), do hereby authorize M/s..... (Bidder's name),having its office at ..... (Bidder's address) to submit the bid and sign the contract with Doordarshan for the products offered by us against the above tender.

Signature .....

Name & Designation of authorized signatory.....

Name of the OEM - .....

Stamp

*am*

*Loh* *Himanshu C*



Annexure III of Appendix-D

**OEM LETTER HEAD**

CERTIFICATE FOR GUARANTEE/WARRANTY

Date:

Tender No. :

We, M/s ..... (Name and address of the OEM), do hereby confirm that:

All the offered equipment shall be guaranteed against any defect for a period of 5 (Five) years as per terms and conditions of tender document.

1. Any part failing during the Guarantee/Warranty period shall be repaired/replaced free of charge by the successful bidder at site. For repairing of any defective equipment during Guarantee/Warranty period, the defective module or equipment requiring repairs will be handed over to local office/local authorized representative/ dealer who will arrange repairs locally at site or send/export the defective modules to OEM factory and re-import/send back after repairs.
2. It is the responsibility of M/s -----, ( their local office/ Authorized representative/ dealer of the bidder) to arrange the repair/ replacement of faulty items for Doordarshan i.e. no transportation charges would be paid by DD for transporting the defective/ repaired items, if required to be removed from site, during the Guarantee/Warranty period.
3. Guarantee/Warranty period of Equipment or spare parts thereof replaced is to be extended corresponding to the outage period from the date of acceptance, if the failure rectification takes more than 30 days time.
4. All software being offered, are to be licensed to Doordarshan on perpetual basis without specifying any time limit or without specifying end of life of the software. Software upgrades within Guarantee/Warranty period will have to be supplied free of cost.

Signature .....

Name & Designation of authorized signatory.....

Name of the OEM- .....

Stamp

Handwritten signatures and stamps at the bottom of the page, including a circular stamp on the left and several handwritten names and initials.

Annexure IV of Appendix-D

**OEM LETTER HEAD**

**CERTIFICATE FOR AFTER SALES SERVICE SUPPORT**

Date:

Tender No. :

We, M/s ..... (Name and address of the OEM), do hereby confirm that after sales service support for additional **Two (2) years** for the repairs/maintenance of offered products after the completion of **Five (5) years** guarantee/ warrantee period shall be provided through our representatives/authorized dealer/service provider for the offered equipment and accessories in India as mentioned below:

S. No.	Name of the authorized person	Name & Address of authorized After Sales & Support Office/Firm	Telephone/ Fax	Email of the concerned personnel
1				

Signature .....  
Name & Designation of authorized signatory.....  
Name of the OEM - .....  
Stamp

## Annexure V of Appendix-D

**BIDDER LETTER HEAD****DECLARATION BY THE BIDDER**

1. Bill of Material (BOM)- : [Yes/No]
2. Bidder's compliance (As per specs clause no. 8.1.(a)) : [Yes/No]
3. The copy of Dealer Possession License in case of possession of RF equipment ( if applicable) : [Yes/No]
4. Copy of the Memorandum of Understanding (MOU) of Consortium/Joint Venture (If Applicable) : [Yes/No]
5. OEM Compliance for following equipment from their respective OEMs (as per clause no. 8.1.(b)):

S. No.	Name of equipment	Name of OEM	OEM compliance submitted (Yes/ No)
i			
ii			

6. Certificate for Authorization for following equipment from their respective OEMs:

S.No.	Name of equipment	Name of OEM	Authorization certificate submitted ( Yes/ No)
i.			
ii.			
iii.			
.			
.			

7. Certificate for Guarantee/Warranty for following equipment from their respective OEMs:

S.No.	Name of equipment	Name of OEM	Guarantee certificate submitted (Yes/ No)
i.			
ii.			
iii.			
.			
.			

8. Certificate for After sales service support for following equipment from their respective OEMs:

S.No.	Name of equipment	Name of OEM	After sales service support certificate submitted ( Yes/ No)
i.			
ii.			
iii.			
.			
.			
.			

9. Datasheet for the offered equipment as per offered BOM: [Yes/No]

- i.
- ii.
- iii.

Signature

.....  
 Name & Designation of authorized signatory.....  
 Name of the Bidder -

.....  
 Stamp

INDUSTRIAL FEEDBACK

FOR

Annexure VI of Appendix-D

**BIDDER'S LETTER HEAD**

**CERTIFICATE FOR WORK EXPERIENCE**

**Date:**

**Tender No. :**

We, M/s ..... <Name and address of the bidder>, do hereby confirm that details of Work Experience are as follows:

S. No	Description of Work Experience of the Bidder	Details of Work Order No. with date	Copy of Work Order uploaded with bid (YES/NO)	Sr. No. of work/item of the work uploaded order to be considered for work experience of the bidder	Amount /Value in Rupees of the work to be considered for work experience of the bidder	Bidder's Work Experience Category (Please select anyone option i.e. (a) One work of 80% or (b) Two work of 60% or (c) Three work of 40% of Estimated Cost)
1						
2						
3						

Signature .....

Name & Designation of authorized signatory of the Bidder.....

Name of the Bidder.....

Stamp of the Bidder

*[Handwritten signatures and marks]*

Annexure-1

Suggestive Bill of Material (BOM) for Expansion of DD FreeDish Platform by SITC of additional two streams with RF systems at Earth Station Todapur Delhi.

Sl. No.	Description of Item as per Specification (Suggestive BOM)	Quantity as per suggestive BOM		Budgetory Cost in Rupees	
		Total Qty	Unit	Unit Rate	Total Cost
<b>A</b>	<b>INPUT AND BASE BAND SYSTEM</b>				
<b>1</b>	<b>Dual/Single channel L band Amplifier consisting of:</b>				
a	Dual/single channel L band amplifier with built-in LNB power module for 20 Independent signal per set	1	Set		
b	Inbuilt hot swappable Frame controller card for Remote Configuration and Monitoring of signal	1	Set		
c	19" Rack Frame/ Chassis with hot swappable dual Redundant power supply unit and Rack mounting Kit for mounting of dual/single channel L band amplifier with in-built LNB power supply module	1	Set		
d	Low loss L band cable and matching connector with Gold plated Pin as per site requirement (5 meters per signal i.e. 20x5 =100 mtrs (min.) to be connected from L Band splitter to Dual/single channel L band Ammplifier in Porta Cabin as per DRG no. 01.	1	Lot		
e	Low loss L band cable and matching connector with Gold plated Pin as per site requirement (40 meters per signal i.e. 20x60 =1200 mtrs (min.) to be connected from dual/single channel L band Amplifier in Porta Cabin to L band Router in old Compression Room as per DRG no. 01.	1	Lot		
f	Min. 1:4 or as per solution offered with 64x192 L Band Router , L Band passive splitter system (64 Nos Splitters Min.) fitted in 19" Rack Mountable Frame	1	Set		
g	Low loss L band cable and matching connector with Gold plated Pin as per site requirement (5 meters per signal i.e. 20x5 =100 mtrs (min.) to be connected from L Band passive splitter system to Existing L band amplifier both in old Compression Room as per DRG no. 01.	1	Lot		
h	Low loss L band cable and matching connector with Gold plated Pin as per site requirement (40 meters per signal i.e. 20x60 =1200 mtrs (min.) to be connected from Existing L band amplifier in old Compression Room to Existing L band Router in New Compression Room as per DRG no. 01.	1	Lot		

*[Handwritten signatures and initials]*

## 1148406/2024/Sat. Design Section - DG DD

	Low loss L band cable and matching connector with Gold plated Pin as per site requirement i (10 meters per signal i.e. 40x10 =400 mtrs (min.) to be connected from L Band passive splitter system to Existing L band Router both in old Compression Room as per DRG no. 01.	1	Lot		
	Low loss L band cable and matching connector with Gold plated Pin as per site requirement j (10 meters per signal i.e. 20x10 =200 mtrs (min.) to be connected from L Band passive splitter system to New L band Router both in old Compression Room as per DRG no. 01.	1	Lot		
<b>2</b>	<b>L band Router (64x192) with dual redundant power supply consisting of :</b>				
a	Fully wired base unit with 64x192 populated L band router including Crosspoint Matrix module/Mid Matrix cards/Central Switch Board; Hot swappable input cards; Hot swappable output cards; hot Swappable frame controller /Hot swappable CPU card; Hot swappable dual redundant power supply unit etc.	1	Set		
b	Additional Cross Point Matrix module/Mid Matrix Card/Central Switch Board	1	No.		
c	Additional hot swappable Frame Controller Card/CPU Card	1	No.		
d	X-Y/Router control panel with cable	1	Set		
e	Necessary power supply to LNBCs ( one set with each Router)	1	Set		
f	Low loss L band cable and matching connector with Gold plated Pin as per site requirement (40 meters per signal i.e. 22x60 =1320 mtrs (min.) to be connected from L band Router installed in New Compression Room to New L band Router to be installed in old Compression Room as per DRG no. 01.	2	Set		
g	Low loss RF cable and matching F/BNC type connector with Gold plated pin as per site requirement ( 15 meters per signal i.e. 15x 40-600 mtrs (min.)to be connected from New L band Router installed in old Compression Room to existing IRDs (4th and 5th stream) in old Compression Room as per DRG No. 1.	2	Lots		
<b>3</b>	<b>Professional IRDs consisting of:</b>				
a	Professional IRDs with L-band inputs of DVB-S & DVB-S2, DVB-ASI & IP Input compliance decoder (MPEG 2 TS over IP) and DVB-ASI, HD-SDI, SD-SDI, AES/EBU, HD-SDI embedded audio, SD-SDI embedded audio, One downconverted SD-SDI of HD-SDI, Dolby digital (AC-3) 5.1 audio and Dolby Digital Plus 5.1 Audio (E-AC-3) output, MPEG-2 TS over IP output with Multi service filtering facility and having 4:2:0 & 4:2:2 compliant for MPEG-2, H.264/MPEG-4-AVC and 4:2:0 compliant for H.265/HEVC decoding and Common Interface slot hardware, BISS mode-1 & BISS-F Compliant) and dual redundant Power supply unit. (28 Professional IRDs per Lot). Note: No. of Chassis for Professional IRDs shall be dependent on the offered solution.	2	Lots		

## 1148406/2024/Sat. Design Section - DG DD

b	<p>If one Professional IRD per chassis is offered, then four Redundant Chassis with Professional IRD per lot similar to main chassis without any limitation by way of hardware &amp; software upgradation.</p> <p>OR</p> <p>If more than one Professional IRDs per chassis is offered, then two Redundant Chassis with Professional IRDs per lot similar to main chassis without any limitation by way of hardware &amp; software upgradation.</p>	2	Lots		
c	<p>Professional IRDs with L-band inputs of DVB-S &amp; DVB-S2, DVB-ASI &amp; IP Input compliance decoder (MPEG 2 TS over IP) and DVB-ASI, HD-SDI, SD-SDI, AES/EBU, HD-SDI embedded audio, SD-SDI embedded audio, One downconverted SD-SDI of HD-SDI, Dolby digital (AC-3) 5.1 audio and Dolby Digital Plus 5.1 Audio (E-AC-3) output, MPEG-2 TS over IP output with Multi service filtering facility and having 4:2:0 &amp; 4:2:2 compliant for MPEG-2, H.264/MPEG-4-AVC and 4:2:0 compliant for H.265/HEVC decoding and Common Interface slot hardware, BISS mode-1 &amp; BISS-E Compliant) and dual redundant Power supply unit . ( 8 Professional IRDs per Lot).</p> <p>Note: No. of Chassis for Professional IRDs shall be dependent on the offered solution.</p>	2	Lots		
d	<p>If one Professional IRD per chassis is offered, then four Redundant Chassis with professional IRD per lot, similar to main chassis without any limitation by way of hardware &amp; software upgradation.</p> <p>Or</p> <p>If more than one Professional IRDs per chassis is offered, then two Redundant chassis with professional IRDs per lot, similar to main chassis without any limitation by way of hardware &amp; software upgradation.</p>	2	Lot		
e	<p>Low loss RF cable and matching F/BNC type connector with Gold plated pin as per site requirement</p> <p>(10 meters per signal i.e. 10x 40=400 mtrs (min.) from New L band Router to new IRDs (TV) installed in old Compression Room as per DRG No. 1 &amp; 2.</p>	2	Lots		
f	<p>Low loss RF cable and matching F/BNC type connector with Gold plated pin as per site requirement</p> <p>(20 meters per signal i.e. 20x (40)=800 mtrs (min.) to be connected from Old L band Router installed in old Compression Room to new IRDs(TV) installed in old Compression Room as per DRG No. 2.</p>	2	Lots		
g	<p>Low loss RF cable and matching F/BNC type connector with Gold plated pin as per site requirement</p> <p>(10 meters per signal i.e. 10x2=20 mtrs (min.) to be connected from New L band Router installed in old Compression Room to 1:12 Splitter (For Radio Chain) installed in old Compression Room as per DRG No. 3.</p>	2	Lots		
h	<p>Low loss RF cable and matching F/BNC type connector with Gold plated pin as per site requirement</p> <p>(20 meters per signal i.e. 20x 2-40 mtrs (min.) to be connected from Old L band Router installed in old Compression Room to 1:12 Splitter (For Radio Chain) installed in old Compression Room as per DRG No. 3.</p>	2	Lots		







## 1148406/2024/Sat. Design Section - DG DD

i	Low loss RF cable and matching F/BNC type connector with Gold plated pin as per site requirement (3 meters per signal i.e. 14x 3=42 mtrs (min.) to be connected from 1:12 Splitter (For Radio Chain) to new IRDs (For Radio Chain) installed in old Compression Room as per DRG No. 3.	4	Lots		
j	HD-SDI Video cables with matching connectors as per site Requirement (DRG No. 2) between the HD SDI output port of all IRDs (For TV) to HD-SDI Patch Panel etc.	1	Lot		
k	HD-SDI Video cables with matching connectors as per site Requirement (DRG No. 2 & 8) between the ASI output port of all IRDs to HD-SDI Patch Panel for Monitoring	1	Lot		
l	HD SDI cable from the output of all Audio Embedder to HD-SDI Patch Panel , HD/SD SDI Router for Radio Chain etc.	1	Lot		
4	<b>IP Data Switches and Network Switches consisting of:</b>				
a	(1+1) IP Data Switch 48 port with inbuilt dual power supply unit and rack mounting kit (For TV Channel).(2 Nos. per set)	2	Sets		
b	(1+1) IP Data Switch 24 port with inbuilt dual power supply unit and rack mounting kit (For Radio Channel).(2 Nos. per set)	2	Sets		
c	IP Network Switch 48 port with inbuilt dual power supply unit with rack mounting kit.	2	Sets		
d	IP Network Switch 24 port with inbuilt dual power supply unit with rack mounting kit.	2	Set		
e	Indoor type CAT-6 Cable with connector as per site requirement and drawing no 2 & 3 (Min 10 mtr x 3 nos of CAT-6 cable x Number of IRD Chasis) + (Min 3 Nos. spare CAT-6 cable in each rack connected to IP Data switch/IP Network switch)	2	Sets		
5	<b>8 AES/EBU SD-SDI &amp; HD-SDI Embedder and associated Accessories for Radio Service consisting of:</b>				
a	8 AES/EBU Digital audio and SD-SDI & HD-SDI Embedder card.	2	Nos.		
b	Audio cable with matching XLR Audio connector for 8 AES/EBU Digital Audio as per site requirement	2	Sets		
c	19" Rack Frame mounting with Frame controller for remote configuration & monitoring; and auto switchable dual redundant power supply unit. One lot consists of 1 set if Two Audio Embedder Card is mounted in one 19" Rack Frame or One lot consists of 2 sets if One Audio Embedder Card is mounted in one 19" Rack Frame.	1	Lot		
d	16 port XLR type, 19" rack mounting Audio Patch Panel	2	Sets		
6	Essential items/works(If any) to complete the installation of Input and Baseband system	1	Set		
7	Installation, testing and system integration of Input and Baseband System	1	Job		
B	<b>Compression System</b>				

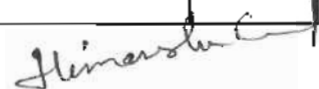

## 1148406/2024/Sat. Design Section - DG DD

<b>8</b>	<b>64 x 64 SD &amp; HD-SDI router wired for all input and out put consisting of:</b>				
a	Base unit Fully wired for 64x64 Input and Output	2	Sets		
b	Inbuilt hot swappable redundant Cross Point module for 64 x 64	2	Sets		
c	Inbuilt hot swappable redundant controller/ logic modules	2	Sets		
d	Inbuilt hot swappable Redundant Power supply unit	2	Sets		
e	X-Y control panel with cable	2	Nos.		
f	Single Bus remote control panel with cable	2	Nos.		
<b>9</b>	<b>HD-SDI Patch Panel and Patch cord consist of:</b>				
a	HD-SDI Patch Panels (75 Ohm Impedence) for all Input Ports (One Set) and all Output Ports (One Set) of SDI Router as per DRG no. 2. ( 1RU, Normal Through, self terminating type )	2	Lots		
b	HD-SDI Video cables with matching connectors as per site Requirement (DRG No. 2) between the HD SDI Input Patch Panels to Output Patch Panel via 64x64 SDI Router and upto the Input of Encoders.	2	Lots		
c	HD-SDI Patch Cord (Impedence -75 Ohm, Cable Length- 3 feet (Minimum) matching with Patch panel	50	Nos.		
d	HD-SDI Patch Cord (Impedence -75 Ohm, Cable Length- 10 feet (Minimum) matching with patch panel	16	Nos.		
<b>10</b>	<b>Digital Encoder operating on 4:2:0 mode with MPEG-2, H.264/MPEG-4 and H.265/HEVC compression without any limitation by way of hardware &amp; software upgradation (including Stat Mux support) consisting of :-</b>				
a	Digital encoder with SDI Input signal for 40 SDTV channels in MPEG-2 & H.264/MPEG-4 compression including 16 HDTV channels in H.264/MPEG-4 & H.265/HEVC compression without any limitation by way of hardware & software upgradation. Each encoder chassis shall also be capable to take IP Input (MPEG-2 TS over IP, RTMP, HLS, SRT & ZIXI ) and decode 16 Channel & re-encode SD & HDTV channels as per technical specification of tender document without any limitation by way of hardware & software upgradation. Noise reduction hardware/ software for SD &HDTV, Four stereo audio channel including Dolby Digital (AC-3) 5.1 audio (Decoding & Encoding) & Dolby Digital Plus 5.1 audio (decoding & Encoding) with audio level processor & loudness control, logo inserter, Ancillary data facility in all encoders and Dual redundant power supply units with all encoder chassis.	2	Sets		
b	Two Redundant Digital encoder chassis similar to Main Chassis per set without any limitation by way of hardware & software upgradation.	2	Sets		
<b>11</b>	<b>IP Data and Network Switches Consisting of:</b>				
a	IP Data Switch 48 port with inbuilt dual power supply unit in (1+1 ) configuration ( 2 Nos per set)	2	Sets		
b	IP Network Switch 48 port with inbuilt dual power supply unit with Rack mounting kit.	2	Nos.		
c	Indoor type CAT-6 Network Cable with connector as per site requirement and drawing no 4 & 5 ( min. 5 mtr x 10 nos x 3 nos =150 mtr per set)	2	Sets		

AM

Lok

2

Jinash

12	<b>IP Encapsulator with Multiplexer for Statistical Multiplexing in 2x(1+1) configuration consisting of:</b>				
a	IP Encapsulator with Multiplexer in (1+1) configuration (2 Nos per set) for Static Multiplexing having: i) Minimum Four Independent ASI Input Port with Licenses ii) Minimum Four independent ASI output port with licenses and option of generating free to air ASI Output for monitoring. (iii) Minimum Eight Independent IP data Port (bi-directional) with licenses (for Input data, Independent MPEG-2 TS over IP Output for transmission, Ancillary data, Control & Management) (iv) Minimum four nos 10 Gigabit SFP Port (Bi-directional) with device (v) DVB- CSA(V1 & V2 ) compliant generic CAS encryption and Minimum two DVB-CAS simulcrypt scrambler licenses with ECM & EMM and generic CAS enabled ASI Outputs.	2	Sets		
b	32 input and corresponding 32 output Ports HD-SDI Patch Panels (75 Ohm Impedence) for connecting all Input Ports and Output Ports of IP incapsulators and ASI Router as per DRG no. 4&5. ( Normal Through, self terminating type )	2	Sets		
c	HD-SDI Video cables with matching connectors as per site Requirement (DRG No. 4&5) for interconnection of IP Encapsulators, ASI Router and up to input of the Distribution amplifier.	2	Lots		
13	<b>16x16 or better matrix ASI router (SDI compatible) wired for all input and out put consisting of:</b>				
a	Base unit fully wired for 16x16 or better matrix Input and Output	2	Sets		
b	Inbuilt controller/ logic modules	2	Sets		
c	Inbuilt auto switchable Redundant Power supply unit	2	Sets		
d	X-Y control panel with cable	2	Sets		
e	Single Bus remote control panel with cable	2	Sets		
14	<b>Network Management System(NMS) for Compression equipment consisting of:</b>				
a	Compression equipment control system Software	2	Sets		
b	Compression equipment control system Hardware consisting of rack mounted main server in 1+1 master-slave configuration or Cluster configuration with client license, each server with dual power supply modules; and KVM switch, Integrated Key Board , mouse & rack mount foldable display monitor.	2	Sets		
c	Client work station with required licenses for remote monitoring of all NMS	4	Sets		
d	24 port IP Network switch for NMS monitoring with Client Work station in remote locations	4	Sets		
e	Indoor type CAT-6 Cable with connector as per site requirement and drawing no. 8 & 9 (Min 100 meter per set)	4	Sets		

*AMM / P.R.*

*3*

*Shinash CP*

## 1148406/2024/Sat. Design Section - DG DD

f	Indoor type CAT-6 Cable with connector between 24 port IP Network switch connected in the output of existing NTP Server (in new compression room) and offered IP Network switch for network time synchronisation of compression system, Monitoring system and other associated equipment, as per site requirement and drawing no.4 and 5. (Min 3x60 mtr per set for Compression system cable i.e.(3x60x2)=360 mtr	1	Lot		
g	Indoor type CAT-6 Cable with connector between 48 port IP Data switch connected with existing EPG and PSI/SI Generator/Server (in new compression room) and offered IP Data switch for feeding data to compression system; and Multiviewer for monitoring of IP streams as per site requirement and drawing no.4, 5 and 9. (Min 3x60 mtr per set for Compression system cable i.e. (3x60x2)=360 mtr	1	Lot		
h	Indoor type CAT-6 Cable with connector between 48 port IP Data switch connected with existing IP Router (in new compression room) and offered 48 port IP Data switch connected with Encoders as per site requirement and amended drawing no. 4 and 5. (Min 3x60 mtr per set i.e. (3x60x2)=360 mtr)	1	Lot		
15	<b>3G/HD/SD SDI, DVB/ASI Compliant Distribution Amplifier system consisting of:</b>				
a	3G/HD/SD SDI, DVB/ASI Compliant Distribution Amplifier system for receiving MPEG-2 TS DVB/ASI signal . One set consisting of two Distribution Amplifiers mounted in one chassis with dual redundant power supply. ( 12 Sets to be connected in circuit and 3 sets as cold standby)	15	Sets		
b	Supply and Laying of HD SDI cables with matching connectors for receiving MPEG-2 TS /DVB ASI of each four Compression chains (two existing and two offered) (i.e. from respective ASI Routers) in old compression room to Distribution Amplifier system of respective Digital Satellite Modulators to be installed in Porta Cabin as per site requirement. (Min 5x(90+5+5)X2 mtr = 1000 meters HD SDI cables per lot (8 HD SDI cables set to be connected in circuit and 2 HD SDI cables set laid as cold standby)	1	Lot		
c	Supply and Laying of HD SDI cables with matching connectors for receiving MPEG-2 TS /DVB ASI of each four Compression existing chains (i.e. from respective Distribution Amplifier system) in old compression room to Distribution Amplifier system of respective Digital Satellite Modulators to be installed in Porta Cabin as per site requirement. (Min 5x(90+5+5)X2 mtr = 1000 meters HD SDI cable per lot (8 HD SDI cables set to be connected in circuit and 2 HD SDI cables set as cold standby)	1	Lot		
16	<b>Optical Fiber Communication link (OFC) system for receiving MPEG-2 TS over IP, consisting of:</b>				

*Handwritten signature/initials*

*Handwritten mark*

*Handwritten signature: Himanshu CP*

## 1148406/2024/Sat. Design Section - DG DD

a	Optical Fiber Communication link (OFC) system for receiving MPEG-2 TS over IP. One set Optical Fiber Communication link (OFC) system consisting of two Optical Transmitter mounted in one chassis with dual redundant power supply , two Optical Receiver mounted in one chassis with dual redundant power supply , required SFP optical device cartridges, and standard accessories. ( 8 Sets to be connected in circuit and 2 sets as cold standby)	10	Sets		
b	Supply and Laying of single-mode 24-core outdoor type Optical Fiber Cable between Optical Transmitter to be installed in old compression room and Optical Receiver to be installed in Porta Cabin, alongwith 6 Nos. Fiber Management system , 24 Nos optical Patch Cards (12 Nos at Tx end and 12 Nos at Rx end), and standard accessories for four Compression chains (Two new and two existing) as per site requirement. (Min 150X3 mtr = 450 meters OFC Cable per lot (2 OFC Cable set to be connected in circuit and 1 OFC Cable set laid as cold standby) as per site requirement.	1	Lot		
c	Supply and Laying of single-mode 24-core outdoor type Optical Fiber Cable between Optical Transmitter to be installed in new compression room and Optical Receiver to be installed in Porta Cabin, alongwith 6 Nos. Fiber Management system, 24 Nos optical Patch Cards (12 Nos at Tx end and 12 Nos at Rx end), and standard accessories for four existing Compression chains as per site requirement. (Min 200X3 mtr = 600 meters OFC Cable per lot (2 OFC Cable set to be connected in circuit and 1 OFC Cable set laid as cold standby)	1	Lot		
d	Optical Patch Cards for standby FMS at compression room to Optical Tx and standby FMS at Porta cabin to Optical Rx as per site requirement , (min length 5 meters)	24	Nos		
17	Essential items/Works (If any) to complete the installation of Compression system	1	Lot		
18	Installation , testing and system integration of Compression System	1	Job		
C	<b>Digital Satellite Modulator System.</b>				
19	<b>Digital Satellite Modulators in 8x(1+1) configuration consisting of:</b>				
a	Digital Satellite Modulators capable of Modulating in DVB-S and DVB-S2 (one at a time) and operating in Redundant mode.	16	Nos.		
b	IF Redundancy switch for managing redundancy of (1+ 1) Modulators	8	Nos.		
20	Essential items/Works (If any) to complete the installation of Digital Satellite Modulator system.	1	Lot		
21	Installation , testing and system integration of Digital Satellite Modulator system.	1	Job		
D	<b>RF System</b>				
22	<b>Ku Band Up-converter 2 x (1+ 1) configuration consisting of</b>				
a	IF to Ku Band Up-converter	4	Nos.		
b	RF Redundancy switch for managing redundancy of (1+ 1) Ku Band Up-converters	2	Nos.		
c	Flexible copper IF cable with suitable connectors (75 ohms) from IF patch panel to Up-converters rack (both in Porta cabin):- 16x15 mtrs = 240 mtrs (min.).	1	Lot		

*(Handwritten signature)*

*(Handwritten signature)*

## 1148406/2024/Sat. Design Section - DG DD

d	Flexible copper RF Cable with suitable connectors (50 ohms) from Up-converters to HPA racks:- 2x15 mtrs = 30 mtrs (min.)	2	Lots		
e	1:4 IF passive Splitters along with suitable termination	12	Nos.		
f	1:2 RF passive Splitters (Ku Band) along with suitable termination	3	Nos.		
g	2:1 RF passive Combiners(Ku Band) along with suitable termination	3	Nos.		
h	Essential items /works (If any) to complete the installation of Upconverters	1	Lot		
i	Installation of above Up-converters and redundancy switches and integrating it with KHPA System.	1	Job		
23	<b>Klystron High Power Amplifiers (KHPAs) {with 2x(1+1) configuration} consisting of</b>				
a	2.45 KW Ku-band KHPA	4	Nos.		
b	Solid State Intermediate Power Amplifier(SSIPA) for KHPA (integral with KHPAs)	4	Nos.		
c	Lineariser (Integral with KHPAs)	4	Nos.		
d	RF ganged waveguide switch (consisting of one ganged coaxial switches with respective waveguide output switches along with all necessary dummy loads of required ratings, coaxial and waveguide interconnectors, cooling fans etc.)	2	Lots		
e	High Power Dummy Load, flange WR-75, Ku-Band, 3 Kw (min)	1	No		
f	Ku band Dplxer (along with all necessary dummy/reject loads of required ratings, waveguide interconnectors etc.) (Center frequencies of transponders will be given at the time of order)	1	Lot		
g	Interconnecting rigid waveguide assembly and Attenuators/Terminations for fitting of Dplxers to combine the RF of offered (1+1) KHPA System and RF of existing (3+1) KHPA system, and integrating with up-link Antenna System as per DRG No. 7.	1	Lot		
h	Interconnecting rigid waveguide assembly for integrating the offered (1+1) KHPA system to existing Uplink antenna system as per DRG No. 7.	1	Lot		
i	Supply and installation of aluminum duct or HDPE pipe as per site requirement to take out hot air of each KHPA from KHPA rack to outside the room. ( Min length 4 mtr )	2	Lot		
j	19" wired racks for (1+1) KHPA from the KHPA OEM for mounting eqpt ergonomically in orderly fashion and necessary circuit breakers.	2	Sets		
k	IP Network Switch 48 port with inbuilt dual power supply unit with Rack mounting kit.	1	Set		
l	Essential items /works (If any) to complete the installation of KHPA system	1	Lot		
m	Installation of above KHPAs and integration with existing Uplink antenna System.	1	Job		
24	Automatic Dehydrator (3-5 PSI user configurable) with required accessories and front panel display with remote access through Ethernet/SNMP etc and rack mounting kit	1	Set		
25	<b>Waveguides and Componenets consisting of :</b>				
a	Flexible waveguide (WR 75) with suitable flange connectors (Average Power handling capacity $\geq 1.5$ KW) consisting of:				
(i)	Length- 1 meter (min) - 8 nos. [Flat connector (WR75) at both ends of waveguide]	1	Set		

## 1148406/2024/Sat. Design Section - DG DD

(ii)	Length- 1 meter (min)- 8 nos. [Flat connector (WR75) at one end & Grooved connector at other end of waveguide]	1	Set		
b	Waveguide E-Plane bend (Rate to be quoted per unit basis)	4	Nos		
c	Waveguide H-Plane bend (Rate to be quoted per unit basis)	4	Nos		
d	Waveguide Twist of 90 deg. (WR75) (Rate to be quoted per unit basis) (3 Nos. clockwise and 3 Nos. anticlockwise)	6	Nos		
<b>26</b>	<b>RF Equipment Control system consisting of</b>				
a	RF equipment control system Software	1	Set		
b	19" Rack mountable (1+1) Server with dual power supply along with 17" or bigger foldable LED display, keyboard & mouse with required rack mounting kit along with Processor: Xeon. Intel Xeon E 2300 Series or better processor , RAM: 16 GB or more DDR4 or better, Harddrive: 1 TB or better HDD/SSD in Raid 1 configuration, OS: Microsoft Window server 2022 or better/Enterprise linux operating system or better. USB PORT: minimum 4 nos. USB ports, to remotely control all the supplied equipments through Ethernet ports and should be connected to all the equipment through Fast Ethernet Switch using properly rack wired CAT-5 or CAT-6 cable and RJ-45 connectors. (for Porta Cabin i.e. HPA Room).	1	Set		
c	21" or bigger display, keyboard & mouse with PC (Intel i7, tenth generation or better processor ), 16 GB or more DDR4 RAM, 1 TB or more HDD/SSD, Windows 11 or latest operating system, Graphics card, minimum 4 nos. USB ports, Integrated Audio with external speakers, to remotely control all the supplied equipments through Ethernet ports and should be connected to all the equipment through Fast Ethernet Switch using properly rack wired CAT-5 or CAT-6 cable and RJ-45 connectors including client license (for Monitoring room )	1	Set		
d	IP Network Switch 24 port with inbuilt dual power supply unit with Rack mounting kit for Monitoring Room.	1	Set		
e	Ethernet cable Cat 6 min. 150 meters (as per site requirement)	1	Set		
27	Essential items/works (if any) to complete the installation of RF Control system	1	Lot		
28	Installation of RF Control System and integration with Satellite Modulators, Up-Convertors, KHPAs.	1	Job		
<b>E</b>	<b>Monitoring System</b>				
<b>29</b>	<b>Ku- Band receive setup for down link monitoring consisting of</b>				
a	Ku- band receive antenna 120 cm with LNBF	2	Sets		
b	Ku- band receive antenna 60 cm with LNBF	2	Sets		
c	Installation material for 4 sets Antennae supplied above under line item (a) & (b)	1	Lot		
d	RF cables with connector as per site requirement (minimum 240 mtrs)	1	Set		
<b>30</b>	Essential items/Works (if any) to complete the installation of Ku band Receive Antenna system	1	Lot		

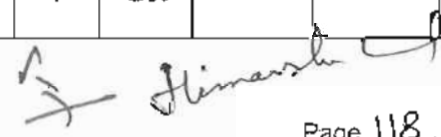
## 1148406/2024/Sat. Design Section - DG DD

31	Installation , testing and system integration of Ku band Receive Antenna System	1	Job		
32	<b>Confidence level Monitoring system consisting of:</b>				
a	17 Inch (Nominal) LCD (TFT/OLED) Professional Broadcast Colour Monitor with integrated speakers with rack mounting Kit	3	Set		
b	Professional grade Integrated Audio/video Monitor with $\geq 3.4''$ TFT/OLED/LCD screen of high resolution and integrated speakers. It should accept 2 HD/SD-SDI Inputs with relocked output, including audio De-Embedder, decoding of Dolby digital (AC-3) 5.1 audio and Dolby Digital Plus 5.1 Audio	2	Nos.		
c	Prof. IRDs {with L-band inputs of DVB-S & DVB-S2, DVB-ASI & IP Input (MPEG 2 TS over IP) } with DVB-ASI, SD-SDI, HD-SDI, AES/EBU, HD SDI embedded audio, SD-SDI embedded audio, One downconverted SD-SDI of HD-SDI, Dolby digital (AC-3) 5.1 audio & Dolby Digital Plus 5.1 Audio (E-AC-3) output, MPEG-2 TS over IP output with Multi service filtering facility and having 4:2:0 & 4:2:2 compliant for MPEG-2, H.264/MPEG-4-AVC and 4:2:0 compliant for H.265/HEVC decoding and Common Interface slot hardware, BISS mode-1 & BISS-E Compliant and dual Redundant Power supply unit. Note: One Professional IRD shall be mounted in one chassis.	6	Nos.		
d	Prof. IRDs {with DVB-ASI & IP input (MPEG-2 TS over IP) } with DVB-ASI, SD-SDI, HD-SDI, AES/EBU, HD SDI embedded Audio, SD-SDI embedded audio, One downconverted SD-SDI of HD-SDI, Dolby digital (AC-3) 5.1 audio & Dolby Digital Plus 5.1 Audio (E-AC-3) output, MPEG-2 TS over IP output with Multi service filtering facility and having 4:2:0 & 4:2:2 compliant for MPEG-2, H.264/MPEG-4-AVC and 4:2:0 compliant for H.265/HEVC decoding and Common Interface slot hardware, BISS mode-1 & BISS-E Compliant and dual Redundant Power supply unit. Note: One Professional IRD shall be mounted in one chassis.	6	Nos.		
e	Multi viewer display system with IP Inputs (MPEG-2 TS over IP) streams of Down link signal monitoring. Multiviewer shall have inbuilt MPEG-2 & MPEG-4 decoders of 16 SDTV with emmbedded audio including MPEG-4 & HEVC decoders of 8 HDTV with Dolby Digital (AC-3) 5.1 audio/ Dolby Digital Plus 5.1 audio Channels (To be installd in portacabin)	1	Set		
f	DVB-S(QPSK) and DVB-S2(QPSK & 8PSK) compliant Demodulator having 8 Independent frequency (L Band) tunner (Minimum) simultaneously with MPEG 2 TS over IP output.	2	Sets		
g	High Quality Digital Audio Amplispeaker having SDI with Emmbded Audio, AES/EBU and Analog Input facility with suitable Power Supply	1	Set		
h	64 x 64 SDI Router with one X-Y pannel, one Single Bus Remote Control Panel, dual Redundant power supply and acccessories	1	Set		
i	32x2 HD-SDI/ASI Patch Panel , 75 Ohm Impedence as per DRG no. 11. ( 1RU, Normal Through, self terminating type )	8	Sets		
j	19" Rack mount 24 Port IP Patch Panel with RJ 45 Connector	1	Sets		
k	IP Patch cord with connector (RJ-45)	6	Set		

*OMM* ✓ *lsl*

*Simarshi*



## 1148406/2024/Sat. Design Section - DG DD

33	<b>Input and Downlink Monitoring of SDTV and HDTV Channels consisting of:</b>				
a	Multi viewer display system with remote panel for IP Inputs (MPEG-2 TS over IP) and [RTMP, SRT, HLS (inbuilt or external decoder)] streams of Input Source signal + 1 no DVI Input+2 Nos SDI Input. Each set of Multiviewer shall have inbuilt MPEG-2 & MPEG-4 decoders of 40 SDTV with embedded audio including MPEG-4 & HEVC Main-10 decoders of 16 HDTV with Dolby Digital (AC-3) 5.1 audio/ Dolby Digital Plus 5.1 audio Channels. Multiviewer shall have two independent video display outputs; and display the name of all channels with their alarms including major alarms on separate monitor as per DRG no. 9.	2	Set		
b	Work station with software licences including one client Licence for controls and configuration of Multiviewer System and Display on 55" Display system	1	Set		
c	De-Modulator cum Descrambler unit (DVB-S & S2) with Common interface slot hardware ( Max 8 Service per CI slot) for 40 TV service and 8 Radio service per Stream per set ( one chassis should consist of multiple modules ). If De-Modulator & Descrambler offered in separate chassis shall also be acceptable.	3	Sets		
d	Multi viewer display system with remote panel for IP Inputs (MPEG-2 TS over IP) and [RTMP, SRT, HLS (inbuilt or external decoder)] streams of Down link signal + 1 no DVI Input+2 nos SDI Input. Each set Multiviewer shall have inbuilt MPEG-2 & MPEG-4 decoders of 40 SDTV with embedded audio including MPEG-4 & HEVC decoders of 16 HDTV with Dolby Digital (AC-3) 5.1 audio/ Dolby Digital Plus 5.1 audio Channels. Multiviewer shall have two independent video display outputs; and display the name of all channels with their alarms including major alarms on separate monitor as per DRG no. 9.	2	Sets		
e	Work stations with software licences including one client licence for controls and configuration of Multiviewer System and Display on 55" Display system	1	Set		
f	IP Data Switch 48 port with inbuilt dual power supply unit and rack mounting kit.	1	Set		
g	Active splitter(L- band) (1:12) ie. 1-input and 12 output with DC Block and dual Redundant Power Supply.	5	Nos.		
h	1:4 ASI passive splitters	4	Sets		
i	24x7 Industrial Grade, Professional Broadcast 55" LCD (LED/OLED) display wall system along with mounting kit	4	Sets		
j	Interconnecting cables from Multi viewer system to 55" LCD (LED/OLED) display wall system for display of each Multiviewer output as per DRG no. 9	1	Set		
k	Supply and Installation of new 55" LCD Monitors with required modification of existing monitoring stand with matching material.	1	Job		
j	42/40 inch (nominal) LED display system having Full HD, 1920 x 1080 Pixels, DVB, PAL, Video Signals HDMI, RF, Component, Sound Type 2.0, Stereo, Audio Formats Supported AAC, AC3(Dolby Digital), EAC3, HAAC, MP3, MPEG, PCM, Inbuilt Speakers-2, USB port 2 (min) Supports Audio, Video, Image; HDMI Ports 2 (min), with mounting stand	2	Sets		

*(Signature)* *Leh*

*(Signature)* *Himanshu*

## 1148406/2024/Sat. Design Section - DG DD

k	Supply and Installation of movable monitoring stand with matching material 42/40 inch (nominal) LED display system	2	Sets		
34	Ku-Band (Downlink) to L-Band Down Converters	2	Sets		
35	70 MHz 1F to L-Band Upconverter	2	Sets		
36	Essential items/Works (If any) to complete the installation of above Monitoring System	1	Lot		
37	Installation , testing and system integration of Monitoring System	1	Job		
F	<b>MEASURING EQUIPMENT</b>				
38	Real Time Signal Analyzer (9kHz to 26.5 GHz or better) with required probe and accessories.	1	Set		
39	Spectrum Analyzer (9kHz to 26.5 GHz or better) with required probe and accessories.	1	Set		
40	Fiber Optic Splicing Machine along with relevant KIT and required accessories like splice protection sleeves packet (consist of min 1000 Pc splice protection sleeves) etc.	1	Set		
41	The test, measuring and maintenance equipment for Optical Fiber and Ethernet link (copper) system, should consist of Micro-Fiber Optic end face Inspection Scope, Cleaning kit, Optical Power meter for Multimode and single mode, Portable handheld Ethernet tester, along with their essential accessories like RJ45-RJ45 patch cord, charger, RJ45/11 universal coupler, required probes, 1310/1550 single-mode source, SC, ST, and LC power meter adapters, carrying case etc(As per project requirement)	1	Set		
42	Colour laser Printer with network printing facility for A4 size	1	Set		
43	B/W laser printer with network printing facility for A3 size	1	Set		
44	Any other essential items/Works to complete the Measuring system	1	Lot		
45	Installation , testing and system integration of Measuring System	1	Job		
G	<b>POWER SUPPLY SYSTEM</b>				
46	SDBs with industrial MCCBs & MCBs, PDPs and Power supply cables to meet the requirement of all supplied equipment with 30% (Nominal) spare capacity to connect additional rack load in future consisting of:				
a	Supply, Laying and Integration of Power supply Cables (4 Core Copper ) with connectors between existing (1+1) UPS PDP and all new SDBs in old compression room & Monitoring room ( Minimum length-70 mtr).	1	Set		
b	Supply, Laying and Integration of Power supply Cables (4 Core Copper ) with connectors between existing (1+0) UPS PDPs and new SDBs in old compression room & Monitoring room ( Minimum length-100 mtr).	1	Set		
c	SDBs with industrial MCCBs & MCBs and three core copper power supply cables to meet the requirement of all equipment supplied in old compression room connected with (1+1) UPS power supply system and (1+0) UPS power supply system as per DRG No.10.	1	Set		

## 1148406/2024/Sat. Design Section - DG DD

d	SDBs with industrial MCCBs & MCBs and three core Copper power supply cables to meet the requirement of all equipment in monitoring room connected with (1+1) UPS power supply system and (1+0) UPS power supply system as per DRG No.10.	1	Set		
e	Supply, Laying and Integration of Power supply Cables (4 Core Copper ) with connectors between existing (1+1) UPS PDP and new SDBs in Porta Cabin (Minimum length-70 mtr).	1	Set		
f	Supply, Laying and Integration of Power supply Cables (4 Core Copper ) with connectors between existing (1+0) UPS PDP and new SDBs in Porta Cabin (Minimum length-100 mtr).	1	Set		
g	SDBs with industrial MCCBs & MCBs and three core copper power supply cables to meet the requirement of all equipment supplied in Porta Cabin connected with (1+1) UPS power supply system and (1+0) UPS power supply system.	1	Set		
47	Essential items/Works (if Any) to complete the Power Supply system	1	Lot		
48	Installation , testing and system integration of Power Supply system	1	Job		
<b>H</b>	<b>MISCELLANEOUS ITEMS</b>				
49	Control & operators table made of powder coated MS sheet or aluminium matching with existing table to install remote operations & control computer, Remote Control panels, 17" Monitor, monitoring panel with Ampli speaker and other relevant equipments.	1	Set		
50	Supply and installation of electronic thermometer & electronic hygrometere inside on top of each rack along with remote configuration and alarm monitoring system as per drawing no. 11.	1	Set		
51	IP Network Switch 48 port with inbuilt dual power supply unit along with rack mounting kit and required CAT 6 Cable & connectors, for control of temperature and humidity	1	Set		
52	Required no. of 19 ", 1000 mm (depth) equipment rack frames (min 18 nos rack ) including Installation material audio video cables and matching IID connectors, CAT-6 cable with RJ-45 connectors, Power Supply cable with connectors etc.	1	Set		
53	Required total sets of Mains Distribution Units (MDUs), each having inbuilt (in MDU) or external, dual input, single phase, automatic power transfer/static switches (Min 36 Sets (18x2) of (MDUs) ) with sequential delayed output on start up, output status LED and IEC-3 pin ( for those equipment which have single power supply input) for equipment in racks.	1	Set		
54	Industrial type 3 pin Male-Female connector ( Min 36 nos ) as per site requirement	1	Set		
55	Earthing system and earth pits (minimum 8 Nos i.e. 4 nos for Compression Room Equipment + 4 nos for Port Cabin Equipment. (Earth Resistance of each pit < 1 ohm)Sample picture is enclosed at DRG No.12.	1	Set		
56	Installation material and laying of cables protection pipes	1	Job		



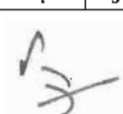
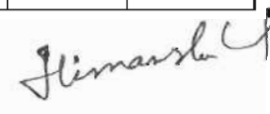



## 1148406/2024/Sat. Design Section - DG DD

57	Providing & installing overhead cable tray with cover as per site requirement for laying of all cables between Porta Cabin (KHPA Room) to old Compression room and old Compression room to new Compression Room	1	Job		
58	Set of tools consisting of video connectors crimping tools with suitable die-sets of all used connectors, BNC puller, HD BNC Puller, cable strippers of all use cables, set of screw drivers and spanners, Allen key set, DC powered screw and nut openers, digital multimeter, digital clamp on meter, weller soldering station and other essential tools required to be used during installation.	1	Set		
59	High quality professional RJ 45 crimping tool suitable for CAT-5 and CAT-6 Data Cables.	1	Set		
60	Inspection tests and analysis, Installation, testing, system integration and commissioning of all equipment supplied in the instant tender for expansion of DTH system	1	Job		
<b>I</b>	<b>DOCUMENTATION</b>				
61	Technical manuals (Hard Copy) for all the equipment supplied	2	Sets		
62	Technical manuals (Softcopy) for all the equipment supplied on DVDs/USBs (with Search facility etc) for the station	2	Sets		
63	All software backups are to be supplied on DVDs/USBs.	2	Sets		
64	Final laminated Technical Block diagram and detailed Line diagrams (in color) of adequate (A1 or bigger) size for all the modules of the final solution in the facility after the completion of the installation. One set shall be mounted on wall and other for record at Station).	2	Sets		
65	The soft editable copy of Final Technical Block diagram and detailed Line diagrams (in color) for all the modules of the final solution after the completion of the installation are to be supplied in a separate USB.	1	Set		
<b>J</b>	<b>TRAINING</b>				
66	Seven separate Seminars (including theoretical & Practical training, hands on experience) for Doordarshan personnel at site. Atleast, Training of each module shall be delivered by the factory Engineer/personnel of OEM. ( This training period is not part of Delivery period).				
a	General Layout (01 working day)	1	Job		
b	Input Base band Equipment (01 working day)	1	Job		
c	Digital compression system including NMS and Digital satellite Modulator system (02 working days)	1	Job		
d	Monitoring and measurement equipment (01 working day)	1	Job		
e	RF System (01 working day)	1	Job		
f	Power Supply System (01 working day)	1	Job		

# Suggestive Block Schematic for SITC of DD FreeDish expansion by Additional Two Streams with RF System - Input Base Band ( L Band Router)

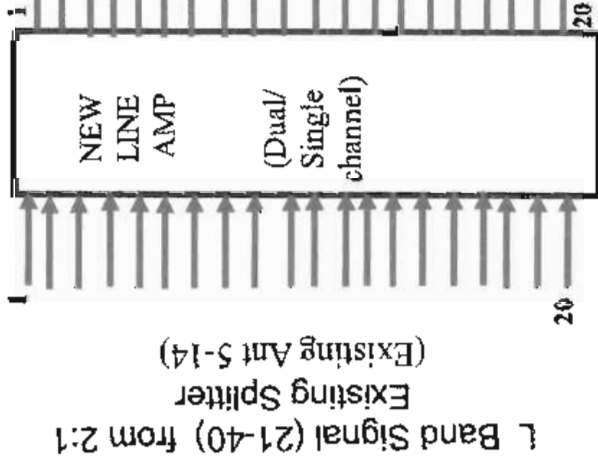
## EXISTING (HPA) PORTA CABIN



L Band Signal (1-20)  
(Existing Line Amplifier connected  
with New Ant 1-6) (Old Ant 1-4)

## OLD COMPRESSION ROOM

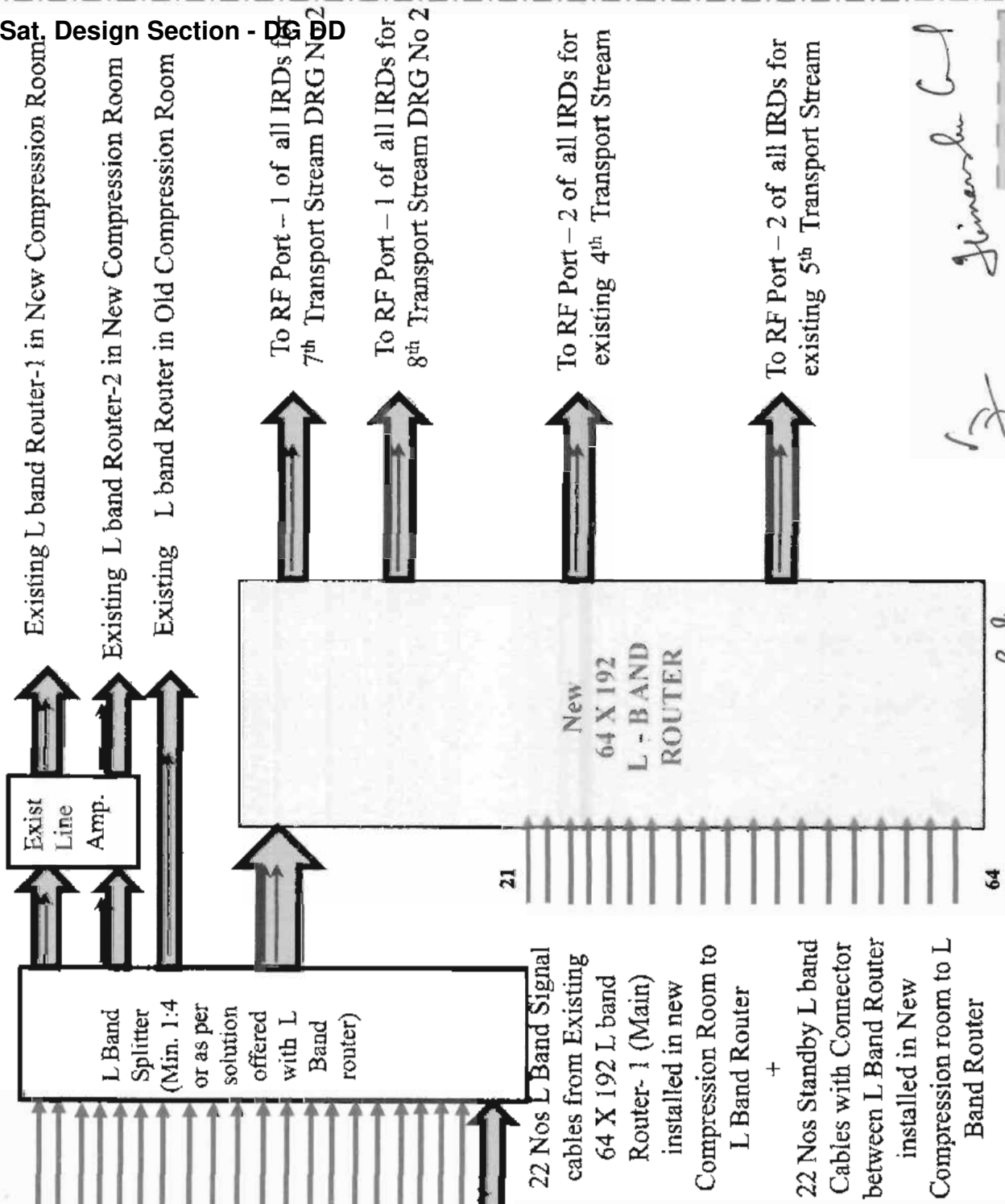

*Handwritten initials and signature*

**Suggestive Block Schematic for SITC of DD FreeDish expansion by Additional Two Streams with RF System**

**Input Base Band ( For 7<sup>th</sup> & 8<sup>th</sup> Stream)**

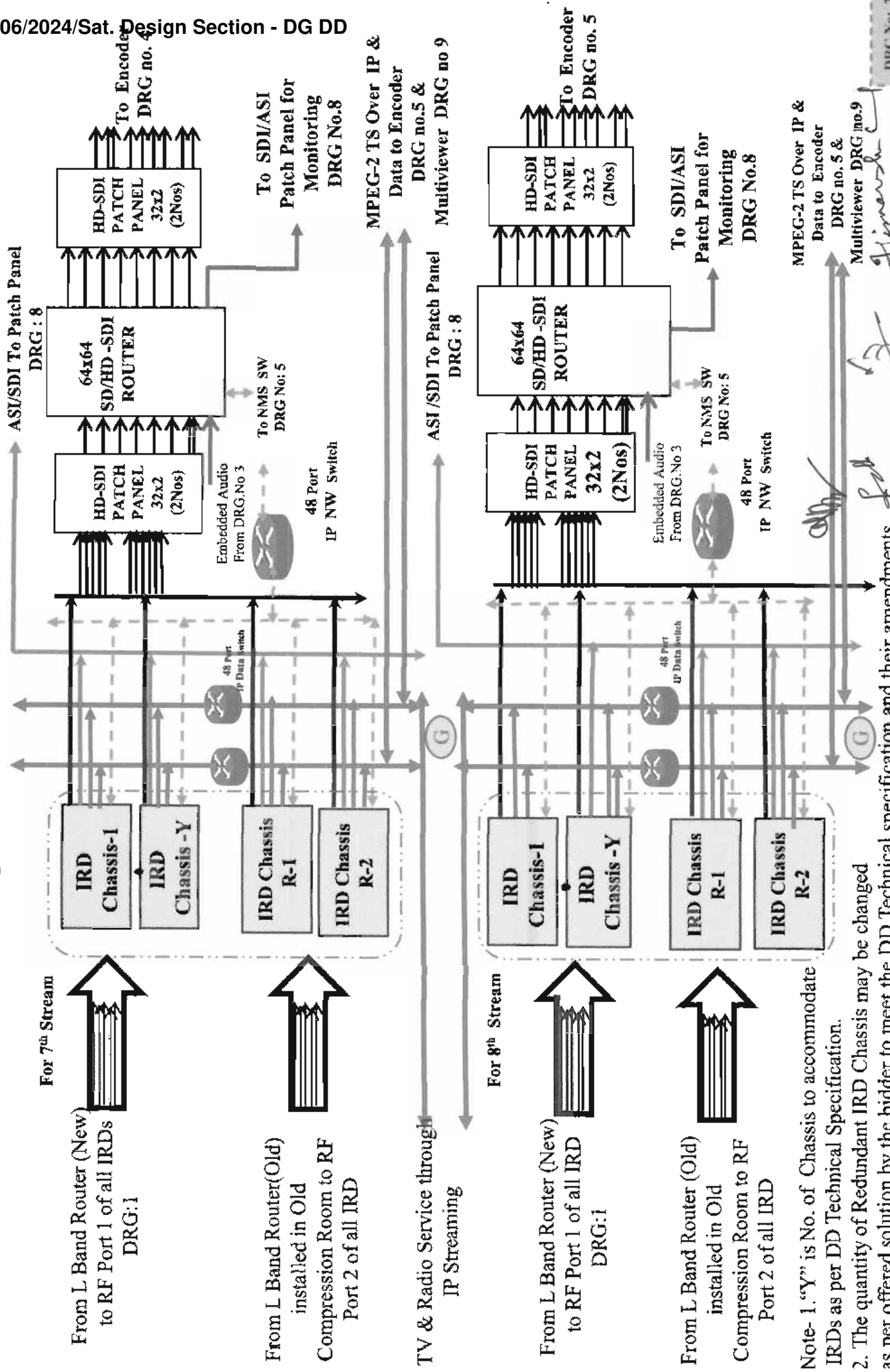

Note- 1. "Y" is No. of Chassis to accommodate IRDs as per DD Technical Specification.

2. The quantity of Redundant IRD Chassis may be changed as per offered solution by the bidder to meet the DD Technical specification and their amendments.

*Signature*  
 DRG No. 1  
 Page 125



Suggestive Block Schematic for SITC of DD FreeDish expansion by Additional Two Streams with RF System

Compression equipment for 7th Stream

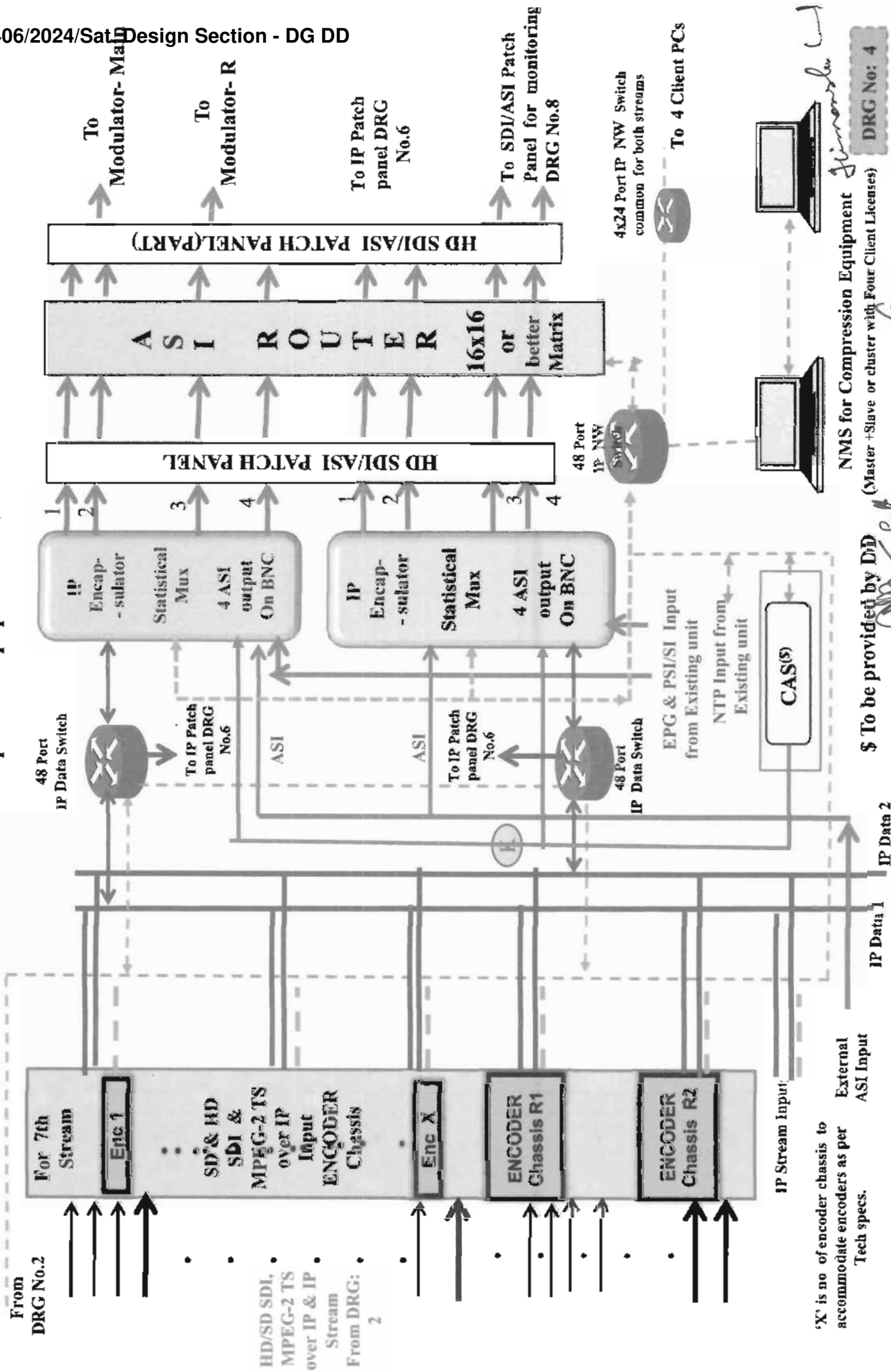

'X' is no of encoder chassis to accommodate encoders as per Tech specs.

\$ To be provided by DD

NMS for Compression Equipment (Master +Slave or cluster with Four Client Licenses)

DRG No: 4

Page 127

*Signature*



Suggestive Block Schematic for SITC of DD FreeDish expansion by Additional Two Streams with RF System

Compression equipment for 8Nth Stream

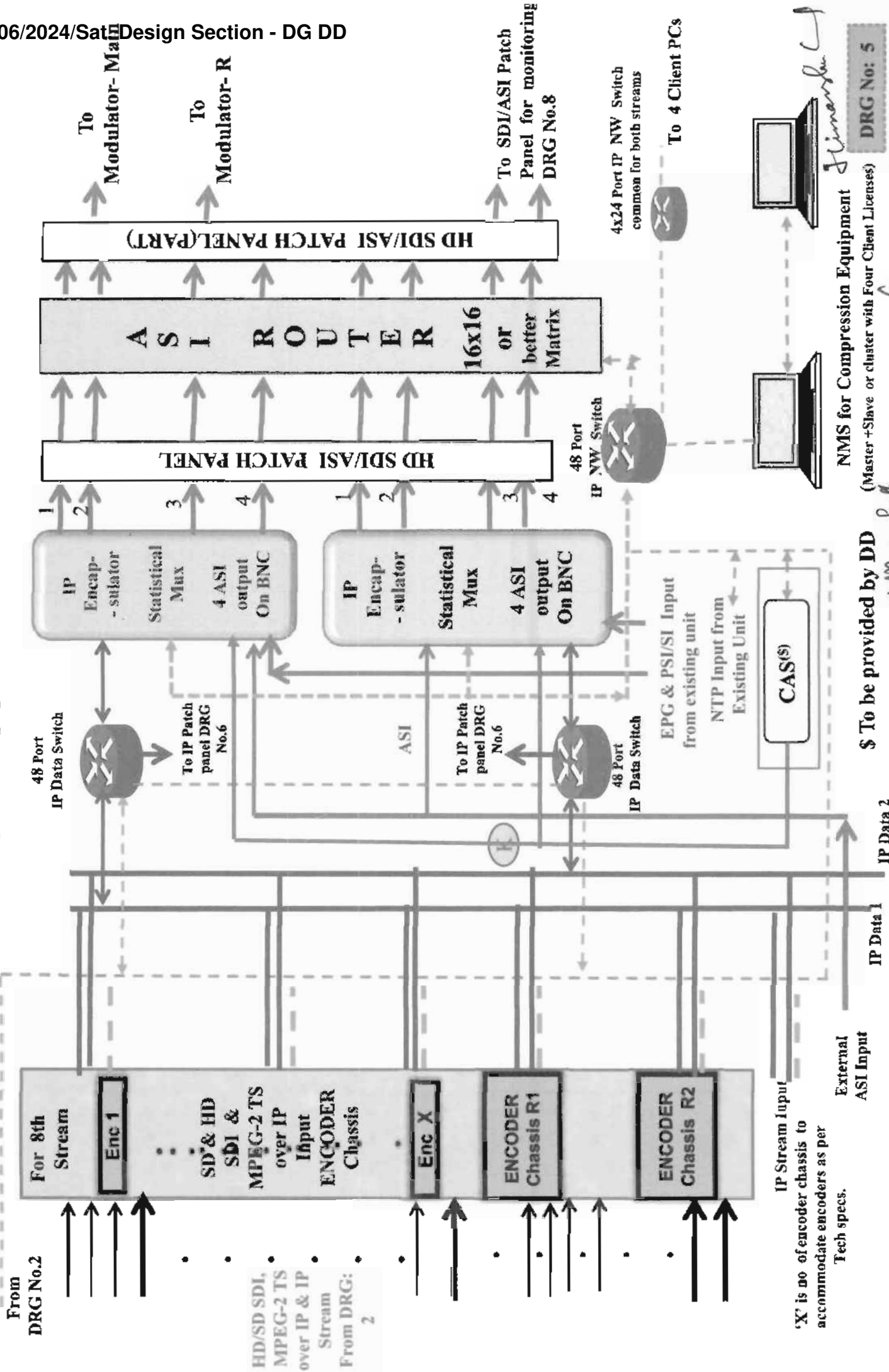

\$ To be provided by DD

NMS for Compression Equipment (Master+Slave or cluster with Four Client Licenses)

DRG No: 5

Page 128

**Suggestive Block Schematic for SITC of DD FreeDish expansion by Additional Two Streams with RF System - (1+1) Satellite Modulator for 4<sup>th</sup>, 5<sup>th</sup>, 7<sup>th</sup> & 8<sup>th</sup> Stream**

148406/2024/Sat. Design Section 8 DG DD

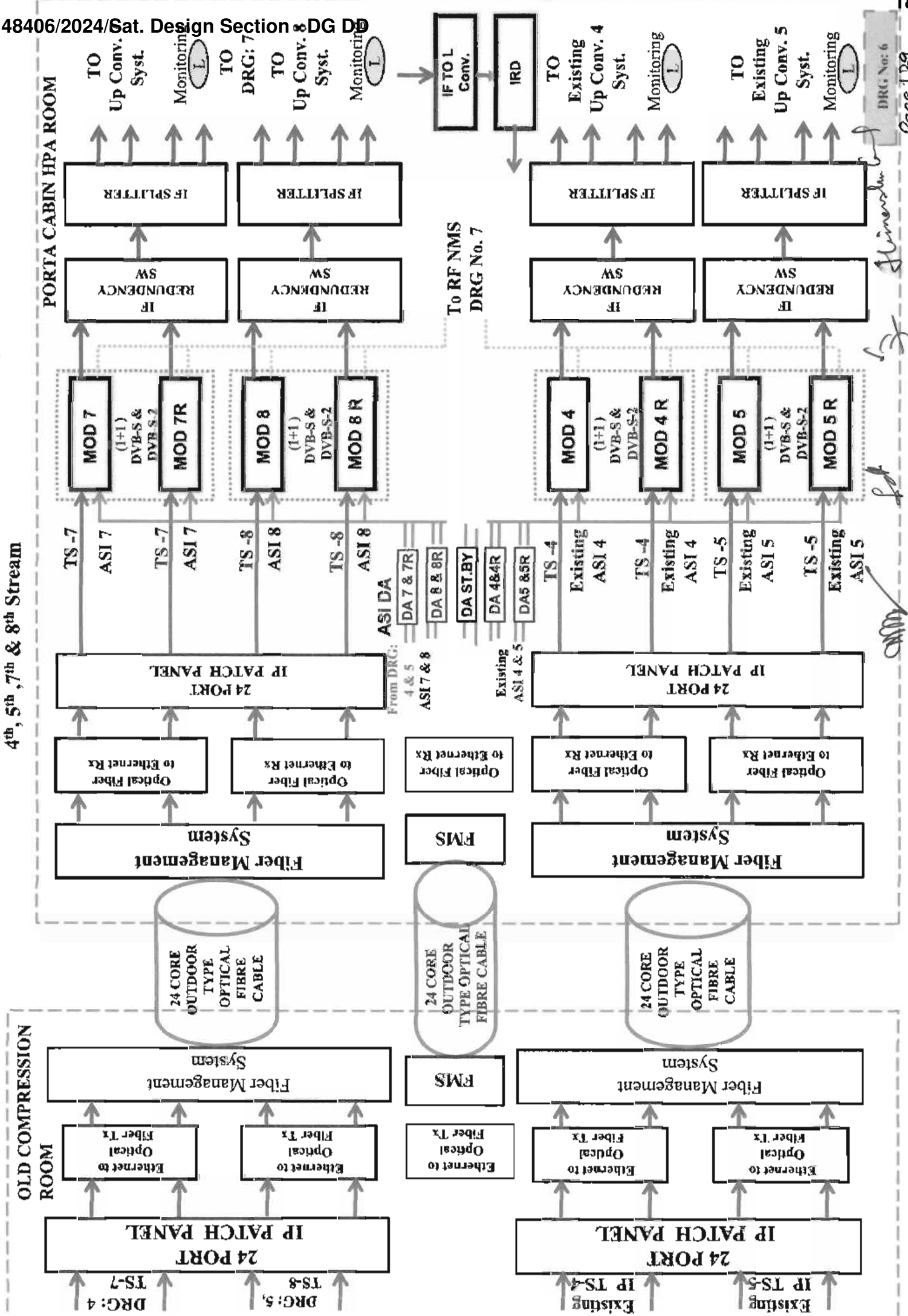

*Handwritten notes and signatures:*  
 S. Jindal  
 S. Jindal  
 S. Jindal

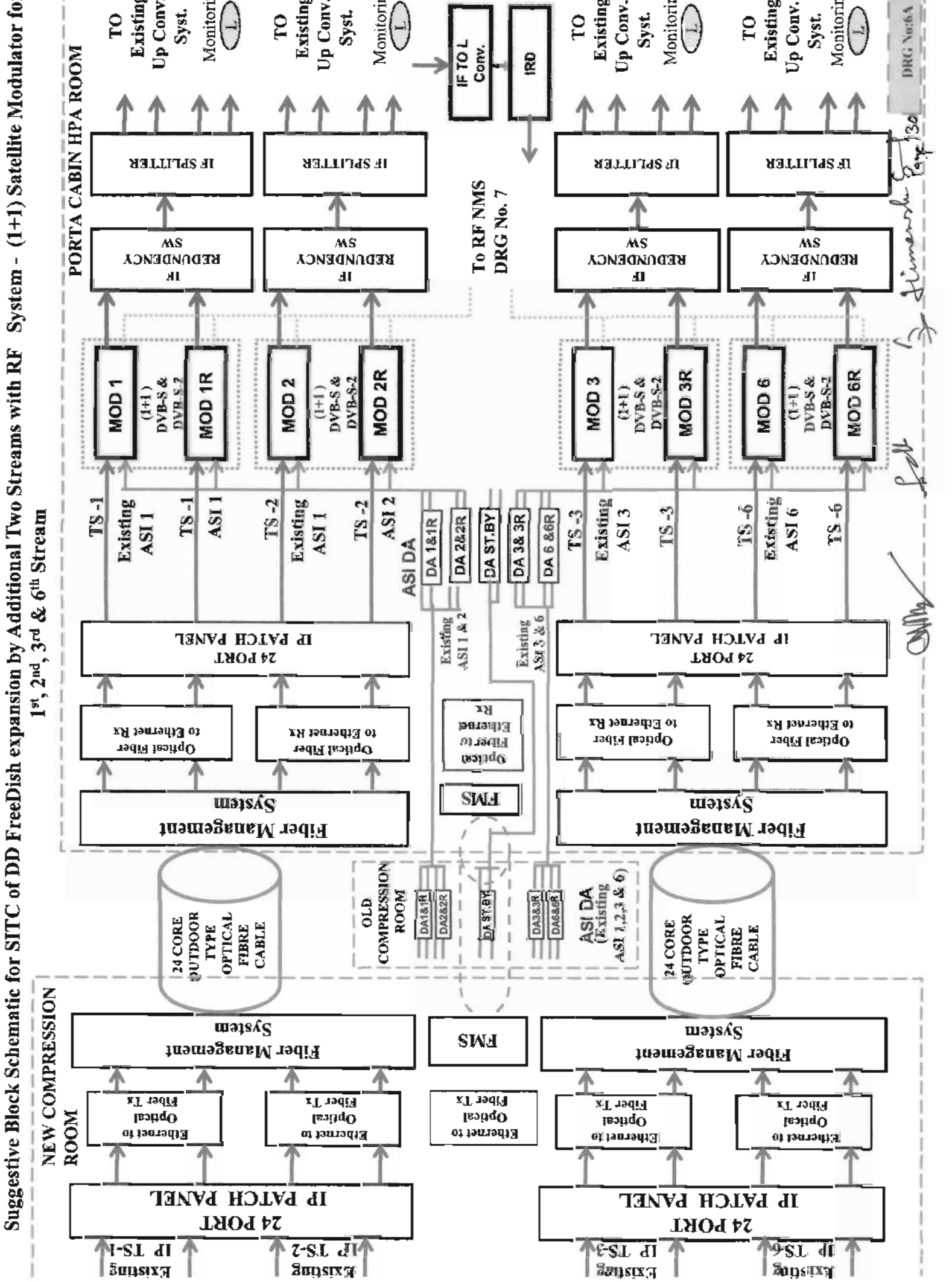

**Suggestive Block Schematic for SITC of DD FreeDish expansion by Additional Two Streams with RF System**  
 (7th IF Stream will be up linked in Horizontal Port of Antenna and 8th IF Stream will be up linked in Vertical Port of Antenna)

06/2024/Sat. Design Section - DG DD

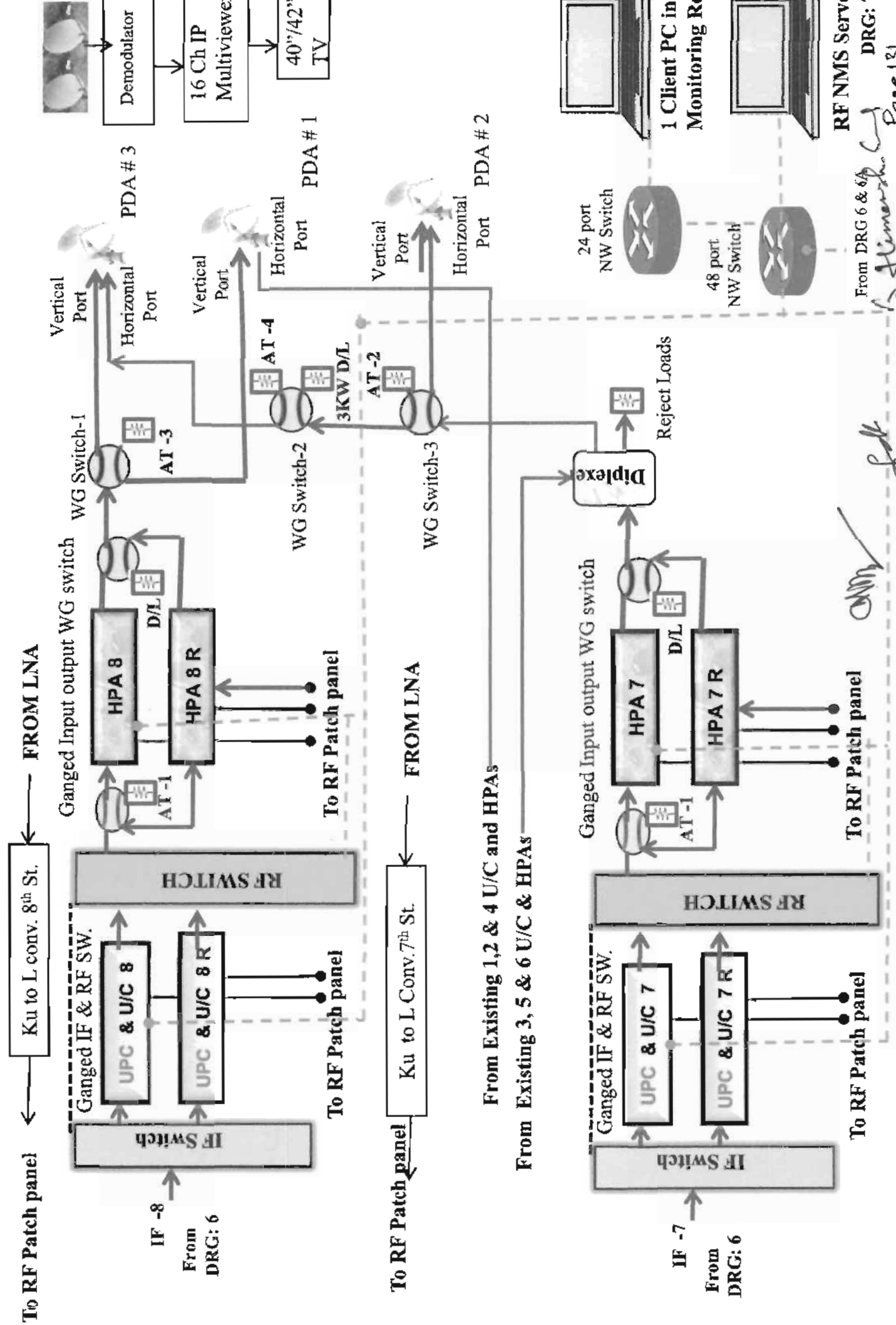

**Suggestive Block Schematic for SITC of DD FreeDish expansion by Additional Two Streams with RF Systems  
Confidence Level Monitoring Setup**

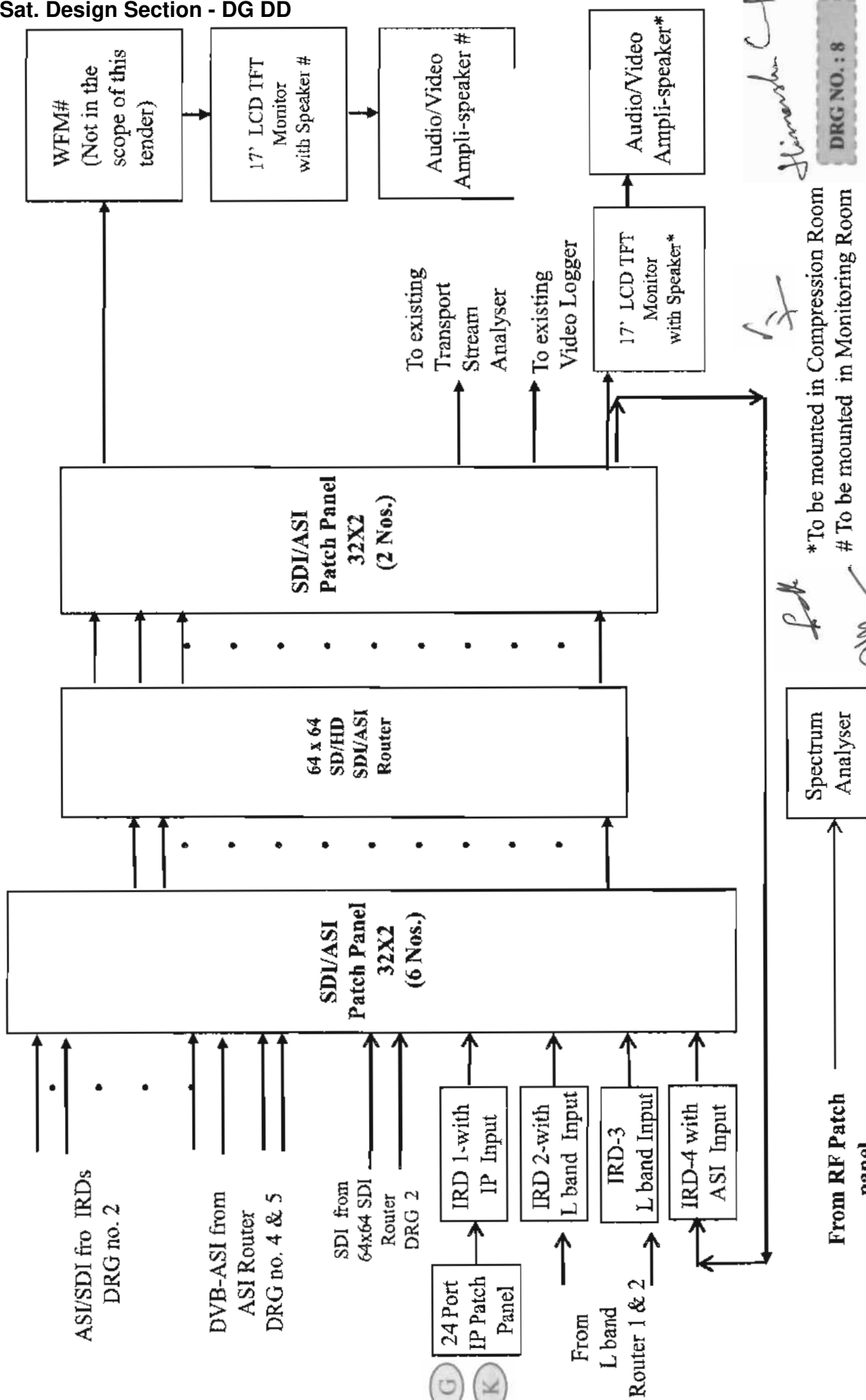

\*To be mounted in Compression Room  
# To be mounted in Monitoring Room

DRG NO. : 8

# Suggestive Block Schematic for SITC of DD FreeDish expansion by Additional Two Streams with RF System for 7th Stream (Same for 8th stream)

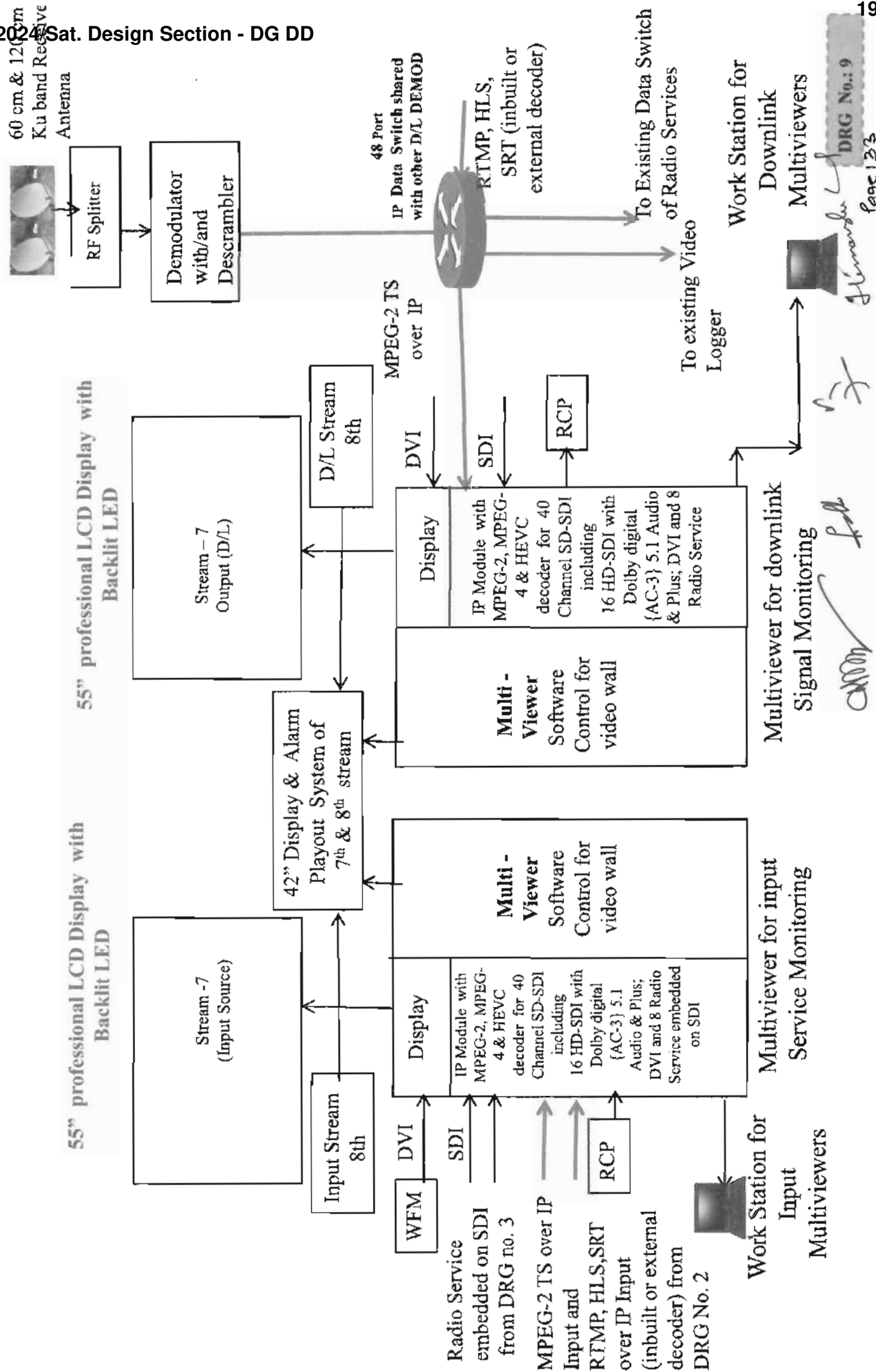

*Handwritten signatures and notes:*  
 DRG No.: 9  
 Page 123

# Suggestive Block Schematic for SITC of DD FreeDish expansion by Additional Two Streams with RF System Power Supply Arrangement

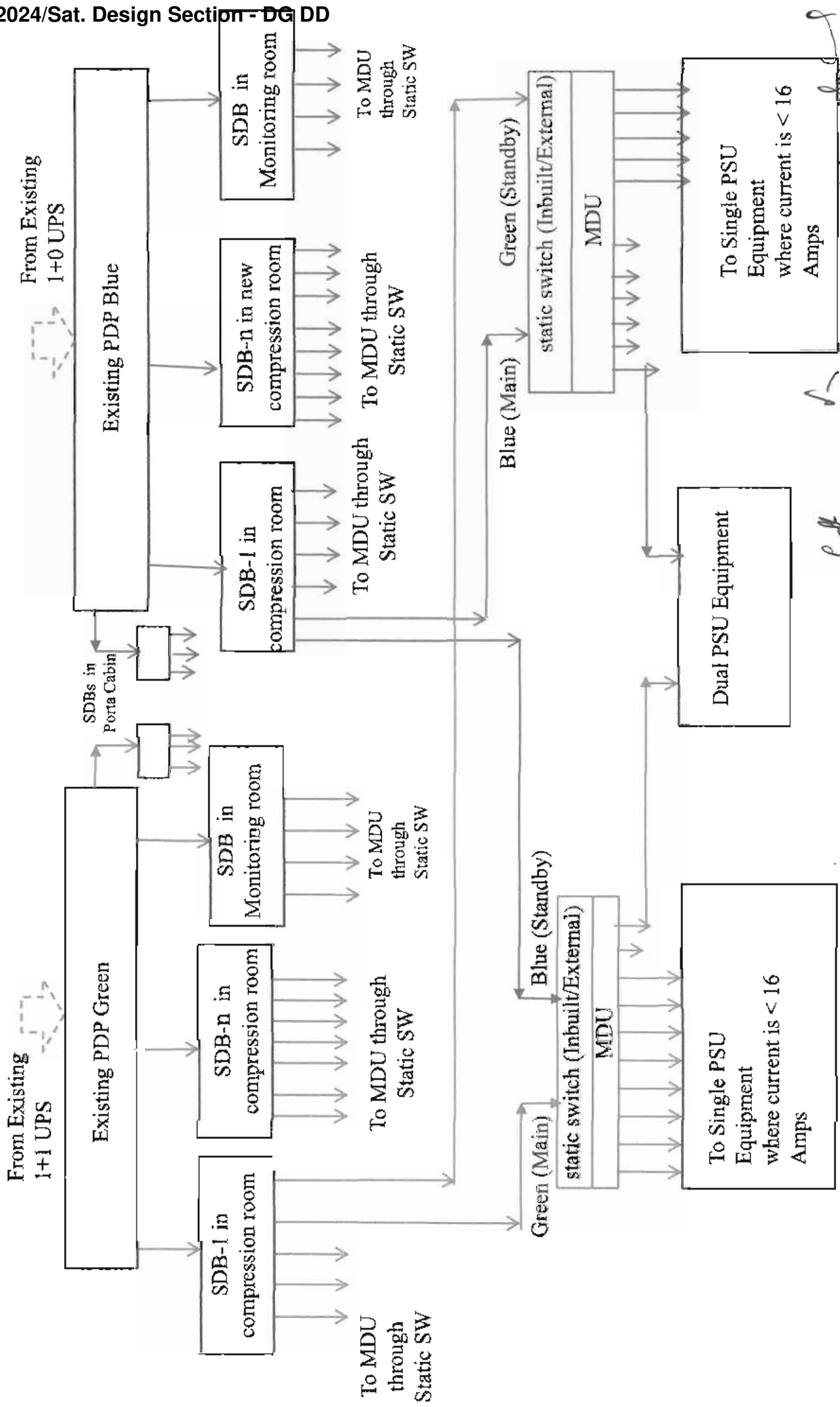

Similarly other MDUs shall be connected to all Equipment rack

Note: Each rack should have both Green and Blue Supply. N = no. of SDBs required to feed Power Supply to each rack.



# Suggestive Block Schematic for SITC of DD FreeDish expansion by Additional Two Streams with RF System Power Distribution, Temp & Humidity Monitoring in Racks

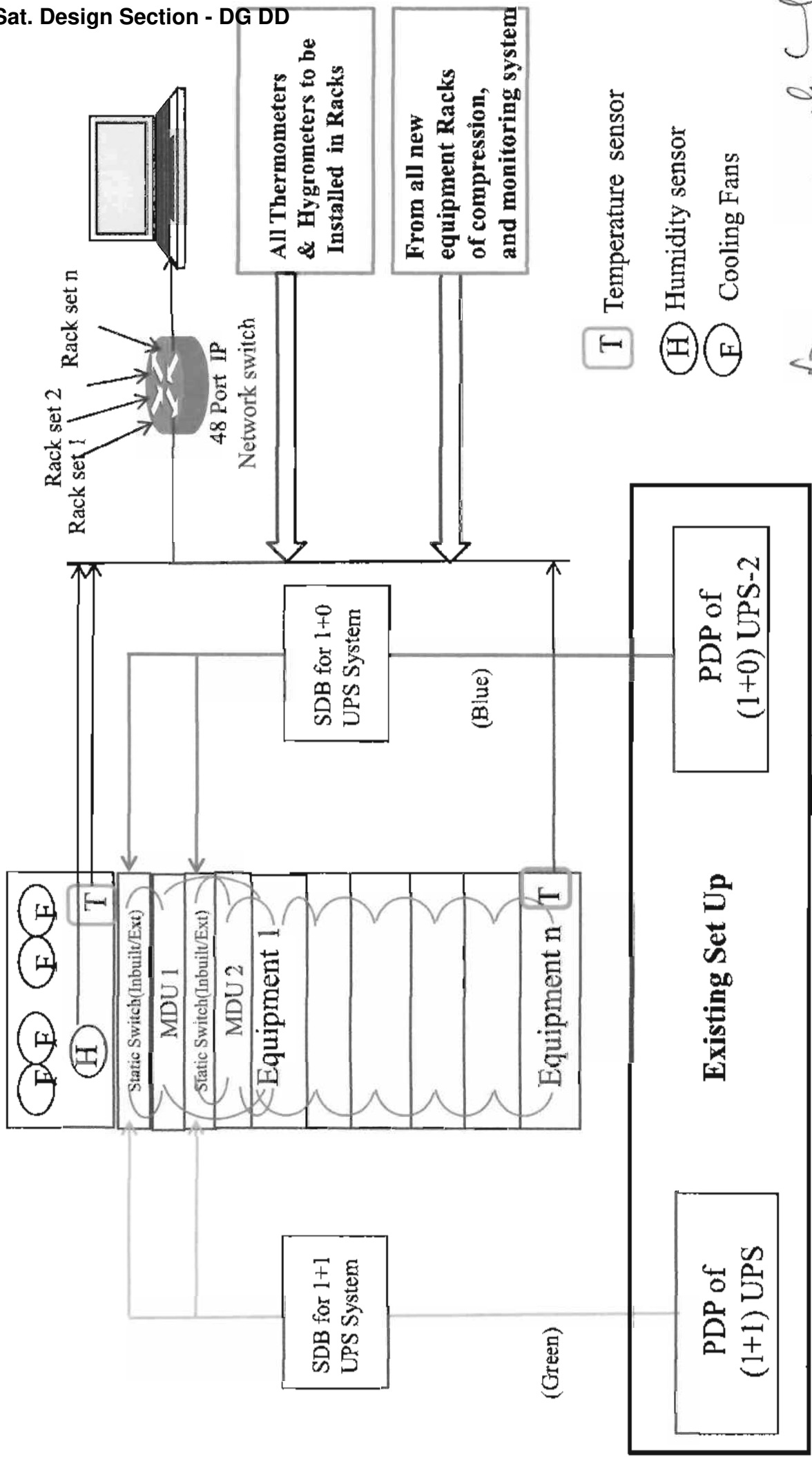

*Handwritten signature*

*Handwritten signature*

DRG No. :11

Page 135



# Suggestive Block Schematic for SITC of DD FreeDish expansion by Additional Two Streams with RF System Earth Pit

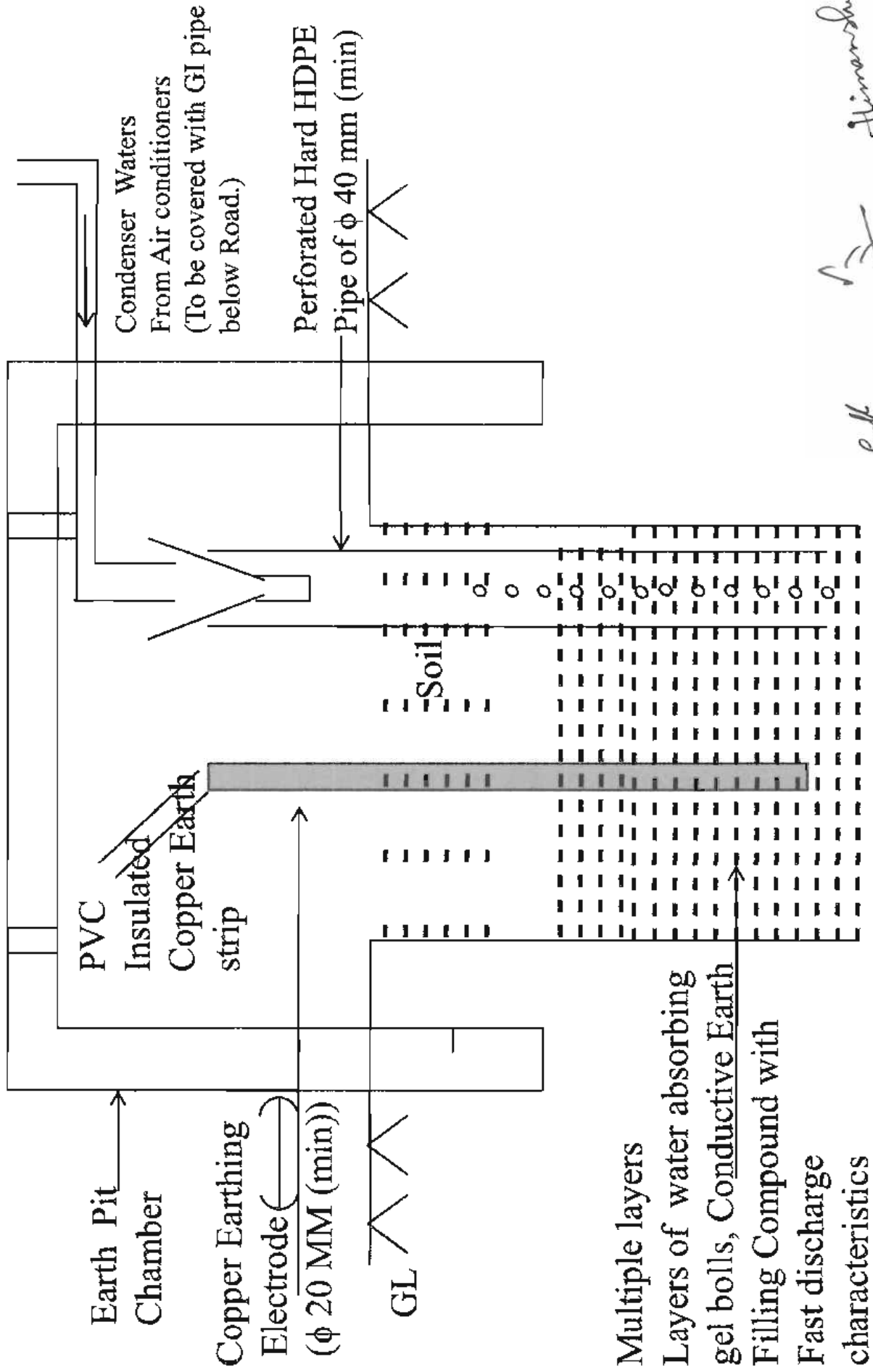

*Handwritten signature*

*Handwritten initials*

*Handwritten initials*

DRG No : 12

Page 136

# Suggestive Block Schematic for SITC of DD FreeDish expansion by Additional Two Streams with RF System

## - Cable Support System

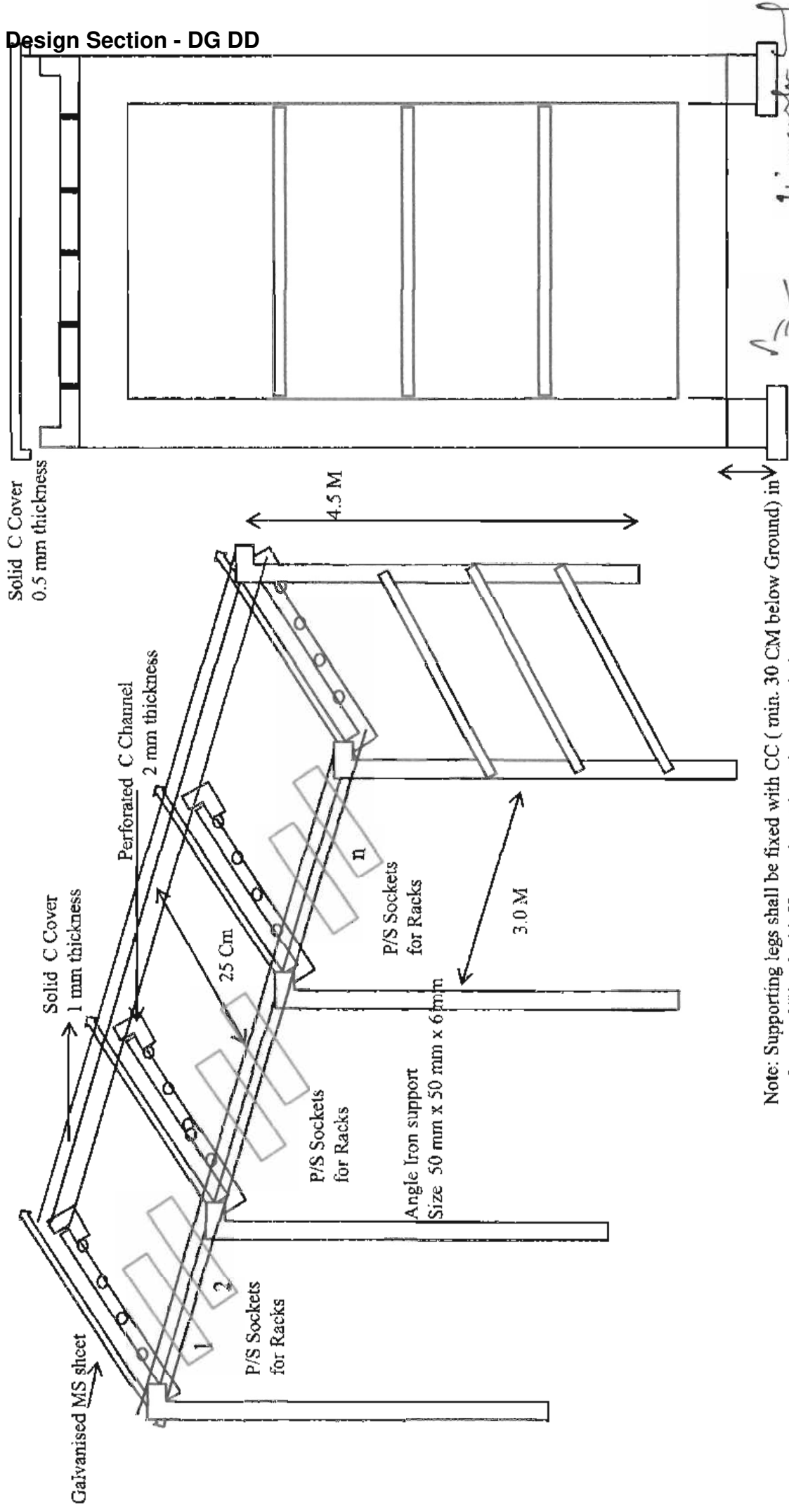

DRG No : 13